

SPECIFICATIONS **CS63CGT1C**

PACKAGE OUTLINES

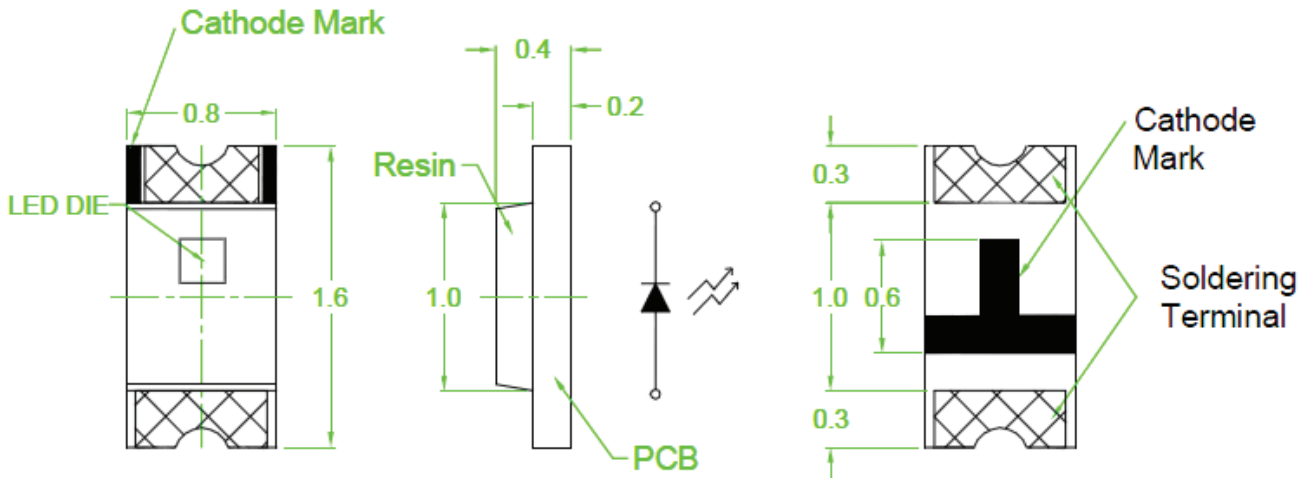

Recommended Pad Layout

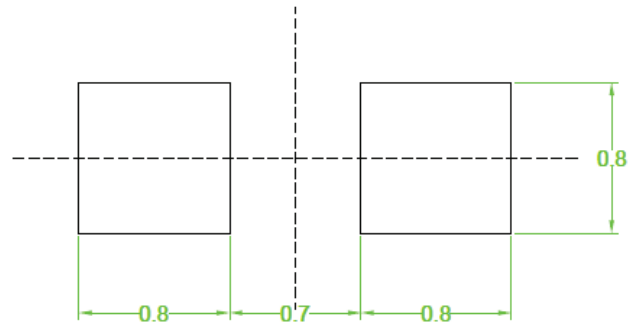

- Notes:
 1. All dimensions are in millimeters (inches);
 2. Tolerances are ± 0.1 mm unless otherwise noted.

Part Number	Chip Material	Color of Emission	Lens Type
CS63CGT1C	InGaN/GaN	Green	Water Clear



ChromeLED Corp. reserves the right to make changes at any time in order to supply the best product possible. The most current version of this document will always be available at: www.chromeled.com

ABSOLUTE MAXIMUM RATINGS

(TA=25°C)

Parameter	Symbol	Value	Unit
Forward current	I _f	20	mA
Reverse current @5V	I _r	50	μA
Power dissipation	P _d	80	mW
Peak forward current (1/10 @ 10kHz)	I _{fp}	100	mA
Electrostatic Discharge	ESD	150	V
Operating temperature range	T _{opr}	-40~+85	°C
Storage temperature range	T _{stg}	-40~+90	°C
Soldering Temperature	T _{sol}	Max 260°C for 5 sec Max	

OPTICAL-ELECTRICAL CHARACTERISTICS

(TA=25°C)

Parameter	Symbol	Test Condition	Min	Typ	Max	Unit
Spectral half bandwidth	Δλ	I _F = 20mA	--	36	--	nm
Peak Wavelength	λ _P	I _F = 20mA	--	518	--	nm
Dominant wavelength	λ _D	I _F = 20mA	--	525	--	nm
Forward Voltage	V _f	I _F = 20mA	--	3.5	4.0	V
Luminous intensity	I _v	I _F = 20mA	200	500	800	mcd
Viewing angle at 50% I _v	2θ ½	I _F = 20mA	--	140	--	Deg

*NOTE: 1. The forward voltage data did not including ±0.1V tolerance 2. The luminous intensity data did not including ±15% tolerance



ChromeLED Corp. reserves the right to make changes at any time in order to supply the best product possible. The most current version of this document will always be available at: www.chromeled.com

DIMENSIONS OF TAPE (Unit: mm)

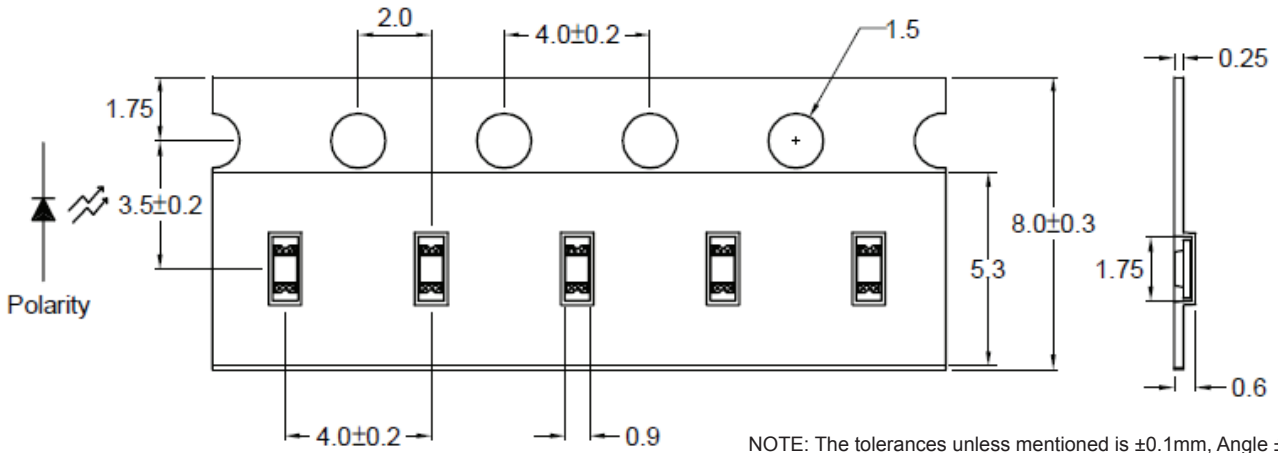

REEL DIMENSIONS

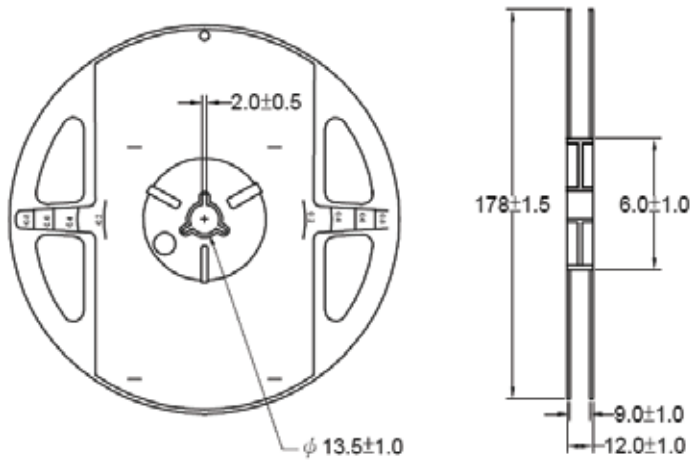

- NOTES:
1. Empty component pockets are sealed with top cover tape;
 2. The maximum number of missing lamps is two;
 3. The cathode is oriented towards the tape sprocket hole.
 4. 4,000pcs/Reel

PACKAGING SPECIFICATION

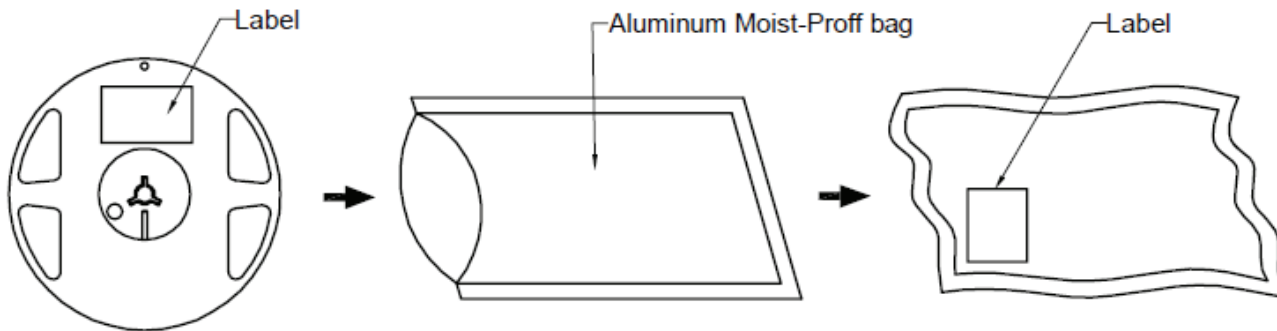

ChromeLED Corp. reserves the right to make changes at any time in order to supply the best product possible. The most current version of this document will always be available at: www.chromeled.com

OPTICAL CHARACTERISTIC CURVES

Fig.1 Forward current vs. Forward Voltage

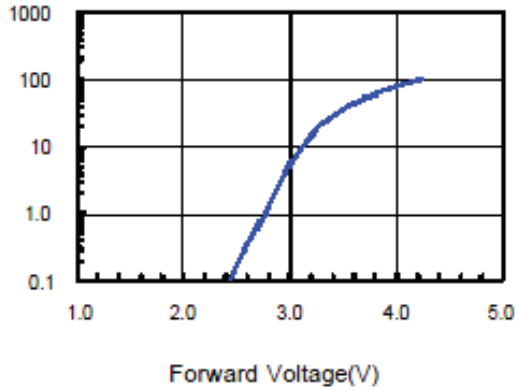

Fig.2 Relative Intensity vs. Forward Current

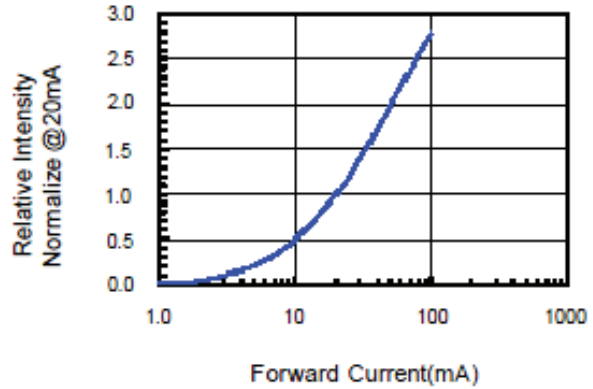

Fig.3 Forward Voltage vs. Temperature

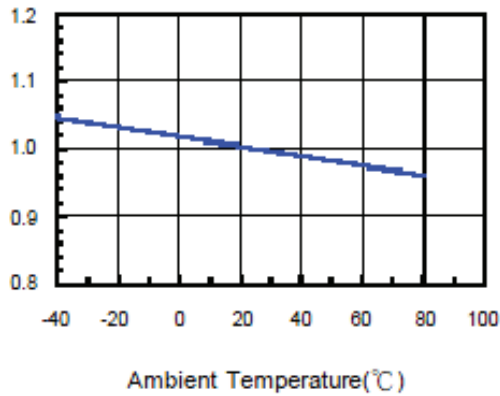

Fig.4 Relative Intensity vs. Temperature

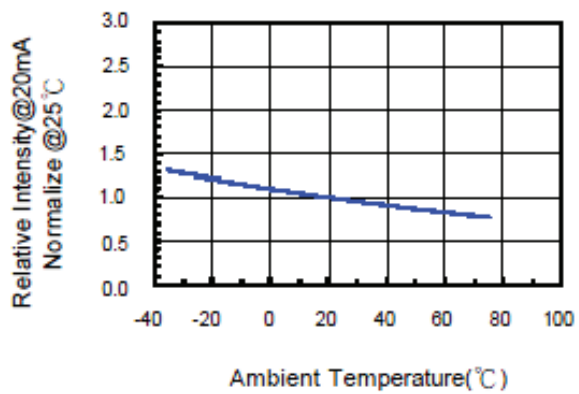

Fig.5 Relative Intensity vs. Wavelength

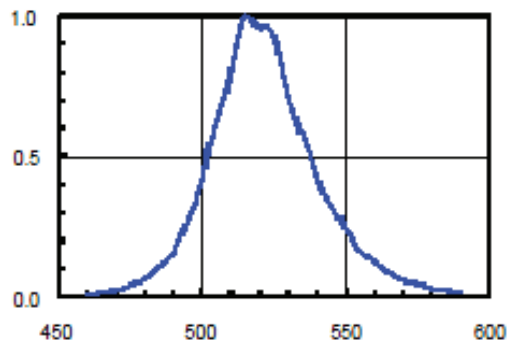
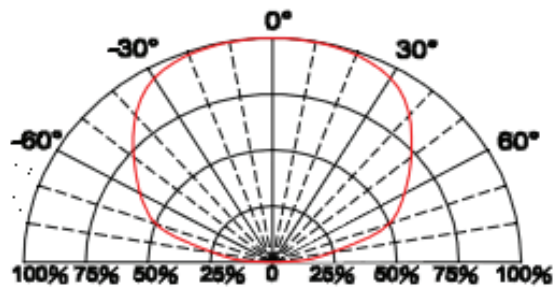

Fig.6 Directive Radiation



ChromeLED Corp. reserves the right to make changes at any time in order to supply the best product possible. The most current version of this document will always be available at: www.chromeled.com

SOLDERING CONDITIONS – LAMP TYPE LED

1. Hand Solder
Basic spec is $\leq 280^{\circ}\text{C}$ 3 sec one time only.
2. Wave Solder

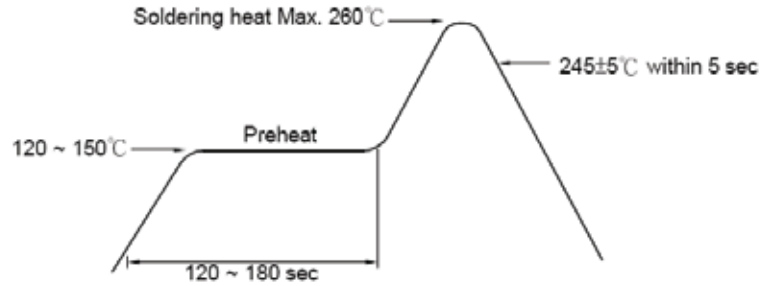

3-1. LEAD Reflow Solder

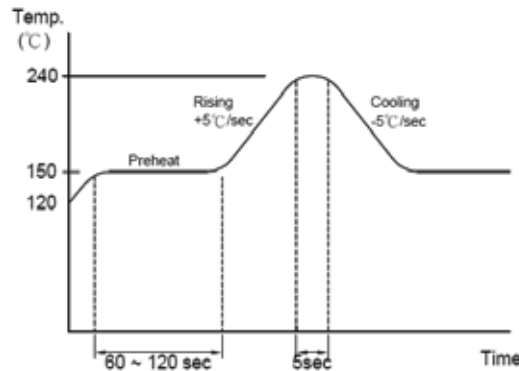

3-2. PB-Free Reflow Solder

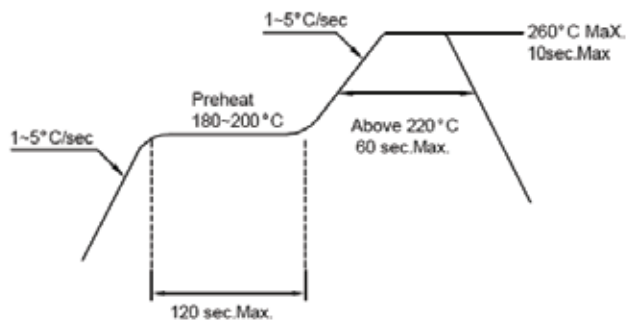

Notes:

1. Reflow soldering should not be done more than two times.
2. When soldering, do not put stress on the LEDs during heating.
3. After soldering, do not warp the circuit board.



ChromeLED Corp. reserves the right to make changes at any time in order to supply the best product possible. The most current version of this document will always be available at: www.chromeled.com