

Type BLR-304

Fuse Block

4 Pole – Regular Auto Blade



www.optifuse.com (619) 593-5050

Specifications:

- Max Current Rating:** 30A per Circuit - 100A Max Input
- Fuse Type:** Regular Auto Blade – APR, ANR Series
- Base:** PBT (UL flame: 94V-0), Black
- Cover:** PC (UL flame: 94V-2), Transparent
- Push Button:** POM (White)
- Terminals:** Copper, Tin plated 0.250" Quick Connect Terminals
- Temperature Rating:** -20° C ~ +85° C

Mechanical Dimensions: Inches [mm]

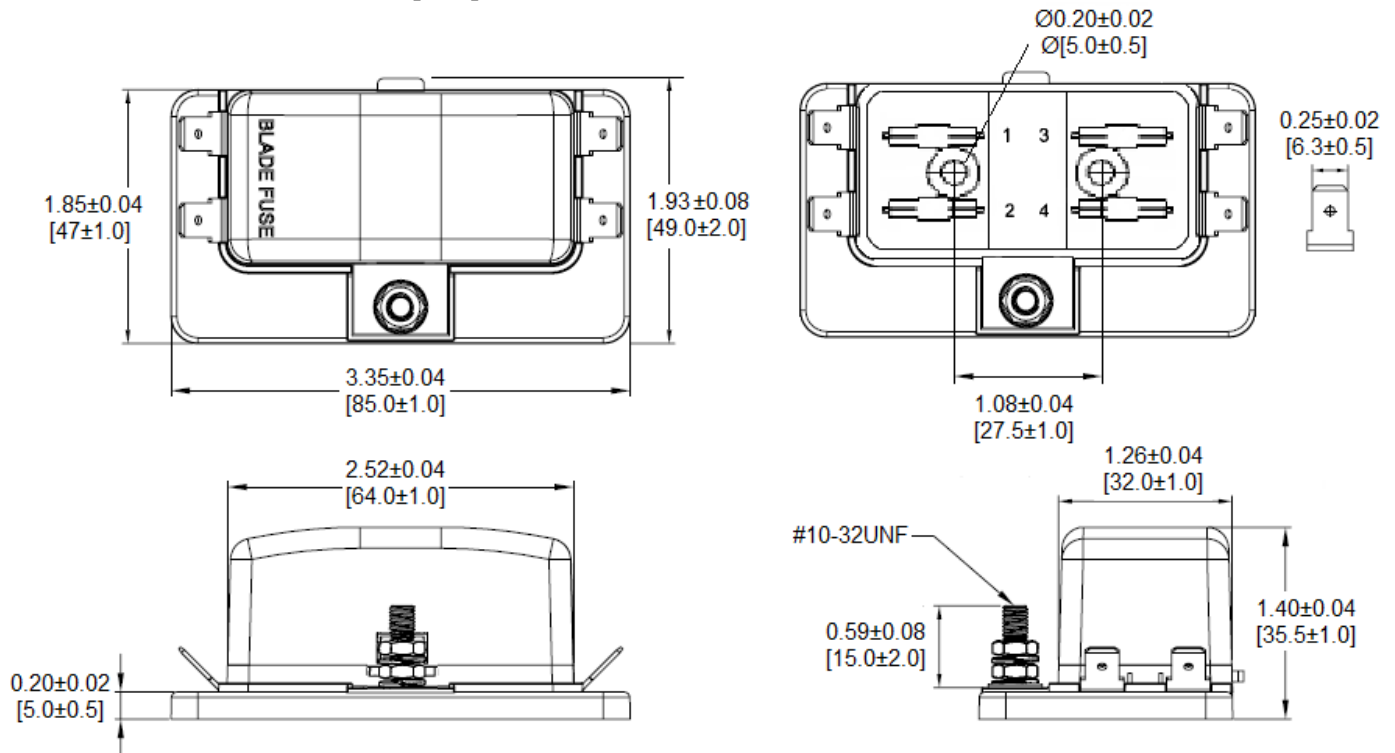

Warning:



-Operation beyond the specified maximum ratings or improper use may result in damage and possible electrical arcing and/or flame.

-Avoid contact of device with chemical solvent. Prolonged contact may damage the device performance.