



**User Manual**

## **AIMB-780**

**Intel® LGA1156 Core i7/i5/i3/  
Pentium/Xeon ATX Motherboard  
with VGA/DVI, DDR3, 4 COM,  
Dual LAN**

*Trusted ePlatform Services*

**ADVANTECH**

---

## Copyright

The documentation and the software included with this product are copyrighted 2008 by Advantech Co., Ltd. All rights are reserved. Advantech Co., Ltd. reserves the right to make improvements in the products described in this manual at any time without notice. No part of this manual may be reproduced, copied, translated or transmitted in any form or by any means without the prior written permission of Advantech Co., Ltd. Information provided in this manual is intended to be accurate and reliable. However, Advantech Co., Ltd. assumes no responsibility for its use, nor for any infringements of the rights of third parties, which may result from its use.

## Acknowledgements

AMI is a trademark of American Megatrends Inc.

IBM and PC are trademarks of International Business Machines Corporation.

Intel® Core 2 Quad, Pentium Dual Core and Celeron are trademarks of Intel Corporation.

WinBond is a trademark of Winbond Corporation.

All other product names or trademarks are properties of their respective owners.

# A Message to the Customer

## Advantech Customer Services

Each and every Advantech product is built to the most exacting specifications to ensure reliable performance in the harsh and demanding conditions typical of industrial environments. Whether your new Advantech equipment is destined for the laboratory or the factory floor, you can be assured that your product will provide the reliability and ease of operation for which the name Advantech has come to be known.

Your satisfaction is our primary concern. Here is a guide to Advantech's customer services. To ensure you get the full benefit of our services, please follow the instructions below carefully.

## Technical Support

We want you to get the maximum performance from your products. So if you run into technical difficulties, we are here to help. For the most frequently asked questions, you can easily find answers in your product documentation. These answers are normally a lot more detailed than the ones we can give over the phone.

So please consult this manual first. If you still cannot find the answer, gather all the information or questions that apply to your problem, and with the product close at hand, call your dealer. Our dealers are well trained and ready to give you the support you need to get the most from your Advantech products. In fact, most problems reported are minor and are able to be easily solved over the phone.

In addition, free technical support is available from Advantech engineers every business day. We are always ready to give advice on application requirements or specific information on the installation and operation of any of our products.

---

# Declaration of Conformity

## FCC

This device complies with the requirements in part 15 of the FCC rules:

Operation is subject to the following two conditions:

- This device may not cause harmful interference
- This device must accept any interference received, including interference that may cause undesired operation.

This equipment has been tested and found to comply with the limits for a Class B digital device, pursuant to Part 15 of the FCC Rules. These limits are designed to provide reasonable protection against harmful interference when the equipment is operated in a commercial environment. This equipment generates, uses, and can radiate radio frequency energy and, if not installed and used in accordance with the instruction manual, may cause harmful interference to radio communications. Operation of this device in a residential area is likely to cause harmful interference in which case the user will be required to correct the interference at his/her own expense. The user is advised that any equipment changes or modifications not expressly approved by the party responsible for compliance would void the compliance to FCC regulations and therefore, the user's authority to operate the equipment.

**Caution!** *There is a danger of a new battery exploding if it is incorrectly installed. Do not attempt to recharge, force open, or heat the battery. Replace the battery only with the same or equivalent type recommended by the manufacturer. Discard used batteries according to the manufacturer's instructions.*



# Memory Compatibility

Brand	Size	Speed	Type	ECC	Vendor PN	Advantech PN	Memory
Transcend	1GB	DDR3 1066	DDR3	N	"TS128MLK64V1U/ TS2KNU28100-1S"	96D3-1G1066NN- TR	SEC K4B1G0846D- HCF8 (128x8)
	1GB	DDR3 1066	DDR3	N	TS128MLK64V1U	96D3-1G1066NN- TR	SEC K4B1G0846D HCH9 ENJ038A3 (128x8)
	2GB	DDR3 1066	DDR3	N	"TS256MLK64V1U/ TS5KNU28300-1S"	96D3-2G1066NN- TR	SEC K4B1G0846D- HCF9(128x8)
Apacer	1GB	DDR3 1066	DDR3	N	78.01GC3.420	96D3-1G1066NN- AP	ELPIDA J1108BABG-AE-E
	1GB	DDR3 1066	DDR3	N	78.01GC3.420	96D3-1G1066NN- AP	ELPIDA J1108BABG-DJ-E (128x8)
	2GB	DDR3 1066	DDR3	N	78.A1GC3.421	96D3-2G1066NN- AP	ELPIDA J1108BABG-AE-E
	2GB	DDR3 1066	DDR3	N	78.A1GC3.421	96D3-2G1066NN- AP	ELPIDA J1108BABG-DJ-E 092109D1P (128x8)
Transcend	1GB	DDR3 1333	DDR3	N	TS128MLK64V3U	NA	SEC 907 HCH9 K4B1G08460(128x8 )
	1GB	DDR3 1333	DDR3	N	TS128MLK64V3U	NA	Micron 9GF22 D9KPT (128x8)
	2GB	DDR3 1333	DDR3	N	TS256MLK64V3U	NA	SEC 907 HCH9 K4B1G08460(128x8 )
Apacer	1GB	DDR3 1333	DDR3	N	"78.A 1GC6.421/ 78.A 1GC6.420"	NA	ELPIDA J1108BABG-DJ- E(128x8)
	2GB	DDR3 1333	DDR3	N	"78.01GC6.420/ 78.A1GC6.421"	NA	ELPIDA J1108BABG-DJ-E (128x8)
DSL	1GB	DDR3 1333	DDR3	N	NA	NA	ELPIDA J1108BABG-DJ-E (128x8)
	2GB	DDR3 1333	DDR3	N	NA	NA	ELPIDA J1108BABG-DJ-E (128x8)
Kingston	1GB	DDR3 1333	DDR3	N	KVR1333D3N9/1G	NA	HYNIX H5TQ1G83BFR H9C 928AK (128x8)
Apacer	4GB	DDR3-1333	DDR3	N	78.B1GDE.AF1	NA	hynix H5TQ2G83AFR H9C 003AK
Kingston	2GB	DDR3-1333	DDR3	N	KHX1333C7D3K2/ 4G	NA	128Mx8bit

## AIMB-780 Feature Comparison

	AIMB-780QG2	AIMB-780WG2
Chipset	Q57	3450
Memory	Non-ECC	Non-ECC/ECC
USB	14	14
GbE	2	2
COM	4	4
SW RAID	Yes	Yes
TPM	Optional	Optional

---

## Product Warranty (2 years)

Advantech warrants to you, the original purchaser, that each of its products will be free from defects in materials and workmanship for two years from the date of purchase.

This warranty does not apply to any products which have been repaired or altered by persons other than repair personnel authorized by Advantech, or which have been subject to misuse, abuse, accident or improper installation. Advantech assumes no liability under the terms of this warranty as a consequence of such events.

Because of Advantech's high quality-control standards and rigorous testing, most of our customers never need to use our repair service. If an Advantech product is defective, it will be repaired or replaced at no charge during the warranty period. For out-of-warranty repairs, you will be billed according to the cost of replacement materials, service time and freight. Please consult your dealer for more details.

If you think you have a defective product, follow these steps:

1. Collect all the information about the problem encountered. (For example, CPU speed, Advantech products used, other hardware and software used, etc.) Note anything abnormal and list any onscreen messages you get when the problem occurs.
2. Call your dealer and describe the problem. Please have your manual, product, and any helpful information readily available.
3. If your product is diagnosed as defective, obtain an RMA (return merchandise authorization) number from your dealer. This allows us to process your return more quickly.
4. Carefully pack the defective product, a fully-completed Repair and Replacement Order Card and a photocopy proof of purchase date (such as your sales receipt) in a shippable container. A product returned without proof of the purchase date is not eligible for warranty service.
5. Write the RMA number visibly on the outside of the package and ship it prepaid to your dealer.

## Initial Inspection

Before you begin installing your motherboard, please make sure that the following materials have been shipped:

- 1 AIMB-780 Startup Manual
- 1 Driver CD (user's manual is included)
- 2 Serial ATA HDD data cables
- 2 Serial ATA HDD power cables
- 1 COM Port cables (2 to 2)
- 1 I/O port bracket
- 1 Warranty card

If any of these items are missing or damaged, contact your distributor or sales representative immediately. We have carefully inspected the AIMB-780 mechanically and electrically before shipment. It should be free of marks and scratches and in perfect working order upon receipt. As you unpack the AIMB-780, check it for signs of shipping damage. (For example, damaged box, scratches, dents, etc.) If it is damaged or it fails to meet the specifications, notify our service department or your local sales representative immediately. Also notify the carrier. Retain the shipping carton and packing material for inspection by the carrier. After inspection, we will make arrangements to repair or replace the unit.

# Contents

## Chapter 1 Hardware Configuration .....1

1.1	Introduction .....	2
1.2	Features .....	3
1.3	Specifications .....	4
1.3.1	System .....	4
1.3.2	Memory .....	4
1.3.3	Input/Output .....	5
1.3.4	Graphics.....	5
1.3.5	Ethernet LAN .....	5
1.3.6	Industrial Features .....	5
1.3.7	Mechanical and Environmental Specifications.....	5
1.4	Jumpers and Connectors .....	6
	Table 1.1: Jumper list .....	6
	Table 1.2: Connectors .....	6
1.5	Board Layout: Jumper and Connector Locations.....	8
	Figure 1.1 Jumper and Connector Locations.....	8
	Figure 1.2 I/O connectors .....	8
1.6	AIMB-780 Block Diagram.....	9
	Figure 1.3 AIMB-780 Block Diagram .....	9
1.7	Safety Precautions .....	10
1.8	Jumper Settings .....	11
1.8.1	How to set jumpers .....	11
1.8.2	CMOS clear (JCMOS1) .....	11
	Table 1.3: JCMOS1 .....	11
1.8.3	Watchdog timer output (JWDT1) .....	12
	Table 1.4: Watchdog timer output (JWDT1).....	12
	Table 1.5: ATX/AT mode selector (PSON1).....	12
	Table 1.6: COM3 RS-232/422/485 mode selector (JSETCOM3)..	12
1.9	System Memory .....	13
1.10	Memory Installation Procedures.....	13
1.11	Cache Memory.....	13
1.12	Processor Installation.....	13
1.13	PCI Bus Routing Table.....	13

## Chapter 2 Connecting Peripherals .....15

2.1	Introduction .....	16
2.2	Floppy Drive Connector (FDD1).....	16
2.3	Parallel Port (LPT1).....	17
2.4	USB Ports (LAN1_USB12, LAN2_USB3/4, USB5/6, USB7/8, USB9/10, USB11/12 & USB13/14).....	18
2.5	VGA Connector and DVI-D Connector (VGA1+DVI1).....	19
2.6	Serial Ports (COM1, COM2, COM3 & COM4) .....	20
2.7	PS/2 Keyboard and Mouse Connector (KBMS1) .....	21
2.8	External Keyboard & Mouse (KBMS2).....	22
2.9	CPU Fan Connector (CPUFAN1).....	23
2.10	System FAN Connector (SYSFAN1 and SYSFAN2) .....	24
2.11	Front Panel Connectors (JFP1, JFP2 & JFP3) .....	25
2.11.1	Power LED and Keyboard Lock (JFP3) .....	25
	Table 2.1: PS/2 or ATX power supply LED status.....	25
2.11.2	External Speaker (JFP2 pins 1, 4, 7 & 10).....	25
2.11.3	HDD LED Connector (JFP2 pins 2 & 5).....	26
2.11.4	ATX Soft Power Switch (JFP1 pins 3 & 6).....	26

2.11.5	Reset Connector (JFP1 pins 9 & 12).....	26
2.12	Line Out, Mic In Connector (AUDIO1) .....	26
2.13	8-pin Alarm Board Connector (VOLT1).....	27
2.14	Case Open Connector (JCASE1) .....	28
2.15	Front Panel LAN Indicator Connector (LAN_LED1).....	29
	Table 2.2: Front Panel LAN Indicator Connector .....	29
2.16	Serial ATA Interface (SATA1, SATA2, SATA3, SATA4, SATA5 & SATA6) 30	
2.17	PCI Slots (PCI 1 ~ PCI 4).....	31
2.18	PCIe x16 Expansion Slot (PCIEX16_1) .....	32
2.19	PCIEX4_1 .....	33
2.20	PCIEX1_1 .....	34
2.21	Auxiliary 4-pin power connector (ATX12V1).....	35
2.22	SPI Flash connector(SPI_CN1) .....	35

## Chapter 3 BIOS Operation ..... 37

3.1	Introduction .....	38
	Figure 3.1 Main setup screen .....	38
3.2	Main Menu .....	39
	Figure 3.2 Main setup screen .....	39
3.2.1	System time / System date .....	39
3.3	Advanced BIOS Features Setup.....	40
	Figure 3.3 Advanced BIOS features setup screen .....	40
3.3.1	CPU Configuration.....	41
	Figure 3.4 CPU Configuration Setting (1).....	41
	Figure 3.5 CPU Configuration Setting (2).....	41
3.3.2	IDE Configuration .....	43
	Figure 3.6 IDE Configuration .....	43
3.3.3	Floppy Configuration.....	44
	Figure 3.7 Floppy Configuration .....	44
3.3.4	Super I/O Configuration .....	45
	Figure 3.8 Super I/O Configuration.....	45
3.3.5	Hardware Health Configuration .....	46
	Figure 3.9 Hardware health configuration .....	46
3.4	ACPI Settings.....	47
	Figure 3.10ACPI Settings .....	47
3.4.1	General ACPI Configuration .....	48
	Figure 3.11General ACPI Configuration .....	48
3.4.2	Chipset ACPI Configuration.....	49
	Figure 3.12Chipset ACPI Configuration .....	49
3.4.3	AHCI Configurition.....	50
	Figure 3.13AHCI Configuration .....	50
3.4.4	ASF Configuration .....	51
	Figure 3.14ASF Configuration .....	51
3.4.5	MPS Configuration.....	52
	Figure 3.15MPS Configuration .....	52
3.4.6	Remote Access Configuration .....	53
	Figure 3.16Remote Access Configuration .....	53
3.4.7	Trusted Computing (Optional) .....	54
	Figure 3.17Trusted Computing Configuration .....	54
3.4.8	USB Configuration .....	55
	Figure 3.18USB Configuration.....	55
3.5	Advanced PCI/PnP Settings .....	56
	Figure 3.19PCI/PNP Setup (top) .....	56
3.6	Boot Settings.....	57
	Figure 3.20Boot Setup Utility .....	57
	Figure 3.21Boot Setting Configuration .....	57
3.7	Security Setting.....	58



	Figure 3.22 Password Configuration .....	58
3.8	Advanced Chipset Settings .....	59
	Figure 3.23 Advanced Chipset Settings .....	59
3.8.1	North Bridge Chipset Configuration .....	60
	Figure 3.24 North Bridge Configuration .....	60
3.8.2	South Bridge Chipset Configuration.....	61
	Figure 3.25 South Bridge Chipset Configuration .....	61
3.8.3	Intel AMT Configuration .....	62
	Figure 3.26 Intel AMT Configuration.....	62
3.8.4	Intel VT-d Configuration .....	63
	Figure 3.27 Intel VT-d Configuration.....	63
3.8.5	ME Subsystem Configuration .....	64
	Figure 3.28 ME Subsystem Configuration .....	64
3.8.6	VE Subsystem Configuration .....	65
	Figure 3.29 VE Subsystem Configuration.....	65
3.9	Exit Option.....	66
	Figure 3.30 Exit Option .....	66

## **Chapter 4 Chipset Software Installation Utility 69**

4.1	Before you begin .....	70
4.2	Introduction .....	70
4.3	Windows XP / Windows 7 Driver Setup .....	71

## **Chapter 5 VGA Setup.....73**

5.1	Introduction .....	74
5.2	Windows XP/Windows 7 Driver Setup .....	74

## **Chapter 6 LAN Configuration.....75**

6.1	Introduction .....	76
6.2	Features .....	76
6.3	Installation .....	76
6.4	Win XP /Win 7 Driver Setup (LAN).....	76

## **Appendix A Programming the Watchdog Timer..77**

A.1	Watchdog timer overview .....	78
A.2	Programming the Watchdog Timer .....	78
	Table A.1: Watchdog timer registers.....	80
A.2.1	Example Programs .....	80

## **Appendix B I/O Pin Assignments.....85**

B.1	Floppy Drive Connector (FDD1).....	86
	Table B.1: Floppy drive connector (FDD1) .....	86
B.2	Parallel Port (LPT1).....	87
	Table B.2: Parallel Port (LPT1).....	87
B.3	USB Header (USB56, USB78, USB910, USB1112 & USB1314) .....	87
	Table B.3: USB Header (USB56,USB78,USB910,USB1112,USB1314)87	
B.4	VGA Connector (VGA1).....	88
	Table B.4: VGA Connector (VGA1) .....	88
B.5	RS-232 Interface (COM3 & COM4) .....	88
	Table B.5: RS-232 Interface (COM1).....	88

B.6	PS/2 Keyboard and Mouse Connector (KBMS1).....	89
	Table B.6: Keyboard and Mouse Connector (KBMS1).....	89
B.7	External Keyboard Connector (KBMS2).....	89
	Table B.7: External Keyboard Connector (KBMS2).....	89
B.8	Infrared (IR) connector (JIR1).....	90
	Table B.8: Infrared Connector (JIR1).....	90
B.9	CPU/System Fan Power Connector (SYSFAN1/SYSFAN2).....	90
	Table B.9: Fan Power Connector (SYSFAN1/CHAFAN1).....	90
B.10	Power LED and Keyboard Lock (JFP3).....	90
	Table B.10:Power LED and Keyboard Lock (JFP3).....	90
B.11	External Speaker Connector (JFP2).....	91
	Table B.11:External Speaker Connector (JFP2).....	91
B.12	Reset Connector (JFP1).....	91
	Table B.12:Reset Connector (JFP1).....	91
B.13	HDD LED Connector (JFP2).....	91
	Table B.13:HDD LED Connector (JFP2).....	91
B.14	ATX Soft Power Switch (JFP1).....	91
	Table B.14:ATX Soft Power Switch (JFP1).....	92
B.15	H/W Monitor Alarm (JOBS1).....	92
	Table B.15:H/W Monitor Alarm (JOBS1).....	92
B.16	SM Bus Connector (JFP2).....	92
	Table B.16:SM Bus Connector (JFP2).....	92
B.17	USB/LAN ports (LAN1_USB12 and LAN2_USB34).....	93
	Table B.17:USB Port.....	93
	Table B.18:Giga LAN 10/100/1000 Base-T RJ-45 port.....	93
B.18	Line Out, Mic IN Connector (AUDIO1).....	93
B.19	Front Panel Audio Connector (FPAUD1).....	94
	Table B.19:Front Panel Audio Connector (FPAUD1).....	94
B.20	8-pin Alarm Board Connector (VOLT1).....	94
	Table B.20:8-pin Alarm Board Connector (VOLT1).....	94
B.21	Case Open Connector (JCASE1).....	95
	Table B.21:Case Open Connector (JCASE1).....	95
B.22	Front Panel LAN LED Connector (LAN_LED1).....	95
	Table B.22:LAN LED Connector (LANLED1).....	95
B.23	SPI_CN1: SPI fresh card pin connector.....	95
	Table B.23:SPI_CN1:SPI fresh card pin connector.....	95
B.24	System I/O Ports.....	96
	Table B.24:System I/O ports.....	96
B.25	DMA Channel Assignments.....	96
	Table B.25:DMA channel assignments.....	96
B.26	Interrupt Assignments.....	97
	Table B.26:Interrupt assignments.....	97
B.27	1st MB Memory Map.....	97
	Table B.27:1st MB memory map.....	97

# Chapter 1

Hardware  
Configuration

---

## 1.1 Introduction

AIMB-780 motherboard is the most advanced Intel Q57/3450 board for industrial applications that require high-performance computing. The motherboard supports Intel Core i7/i5/i3/Pentium/Xeon and DDR3 800/1066/1333 MHz memory up to 16 GB. AIMB-780 provides cost-effective integrated graphics when users install dual core CPUs such as Core i5 6xx, Core i3 and Pentium. The graphics VRAM is 1 GB maximum shared memory with 2 GB and above system memory installed.

When higher graphics performance is needed, AIMB-780 provides a mainstream PCIe x16 expansion slot for add-on graphic cards. In addition, the AIMB-780 has a dual Gigabit Ethernet LAN via a dedicated PCIe x1 bus, which offers bandwidth of up to 500 MB/s, eliminating network bottlenecks. High reliability and outstanding performance make the AIMB-780 the ideal platform for industrial networking applications. By using the Intel Q57/3450 chipset, the AIMB-780 offers four 32-bit, 33 MHz PCI slots; one PCIe x1 slot, one PCIe x4 slot, one PCIe x16 slot and a variety of features such as 6 onboard SATA II interfaces (bandwidth = 300 MB/s) with software for RAID 0, 1, 10 and 5; 14 USB 2.0 connectors and HD Audio. These powerful I/O capabilities ensure even more reliable data storage capabilities and high-speed I/O peripheral connectivity.

The AIMB-780 also adopts Advantech's unique patented Sleep Mode Control Circuit for AT Power Mode.

With all the excellent features and outstanding performance, the AIMB-780 is the ideal platform for today's industrial applications.

**Note!** *Only dual core CPU, such as Core i5 6XX, Core i3 and Pentium processors have integrated Intel® HD Graphics graphic core, quad core processors do NOT have graphic core and need a discrete graphic card for graphic functions.*



## 1.2 Features

- **PCIe architecture:** The Intel Q57/3450 PCH chipset supports 1 PCIe x16 slot, 1 PCIe x4 slot, 1 PCIe x1 slot, and a PCIe x1 link for the Gigabit LAN.
- **High Performance I/O capability:** Dual Gigabit LAN via PCIe x1 bus, 4 PCI 32-bit/33MHz PCI slots, 6 SATAII connectors and 14 USB 2.0 ports.
- **Standard ATX form factor with industrial features:** AIMB-780 provides industrial features like long product life, reliable operation under wide temperature range, watchdog timer, CMOS backup functions, etc.
- **BIOS CMOS backup and restore:** When BIOS CMOS setup has been completed, data in the CMOS RAM is automatically backed up to the Flash ROM. This is particularly useful in harsh environments which may cause setup data loss such as battery failure. Upon such an error occurring, the BIOS will check the data, and automatically restore the original data for booting.
- **Automatically power on after power failure:** It is often necessary to have an unattended system come back to operation when power resumes after a power failure. Advantech's industrial motherboard allows users to set the system to power on automatically without pushing the power on button.
- **Active Management Technology 6.0:** The hardware and firmware base solution is powered by the system auxiliary power plane to remotely monitor networked systems. Intel AMT stores hardware and software information in non-volatile memory. Built-in management provides out-of-band management capabilities, allowing remote discovery and repair of systems after OS failures or when a system is powered down. Alert and event logging features detect problems and quickly reduce downtime, pro-actively blocking incoming threats, containing infected clients before they impact the network, and proactively notifying the user when critical software agents are removed.

---

## 1.3 Specifications

### 1.3.1 System

- **CPU:** LGA1156 Core i7/i5/i3/Pentium/Xeon
- **BIOS:** AMI 64 Mbit SPI
- **System Chipset:** Q57 for QG2 SKU and 3450 for WG2 SKU
- **SATA hard disk drive interface:** Six on-board SATAII connectors support Advanced Host controller interface (AHCI) technology and have data transmission rates up to 300 MB/s
- **Floppy disk drive interface:** Supports one floppy disk drive, 5 1/4" (360 KB and 1.2 MB) or 3 1/2" (720 KB, 1.44 MB). BIOS enable/disable

**Note!** *WG2 sku only supports Xeon 34xx, Core i5 6xx, Core i3 5xx, and Pentium G69XX CPUs*



**Note!** *Core i7, Core i5 7xx and Xeon 34xx quad core processors do NOT have an integrated Intel® HD Graphics graphic core, it's necessary to use a discrete graphic card/module to have video output.*



### 1.3.2 Memory

- **RAM:** Up to 16 GB in four 240-pin DIMM sockets. Supports dual-channel DDR3 800/1066/1333 SDRAM.

**Note!** *A 32-bit OS may not fully detect 4 GB of RAM when 4 GB is installed.*



- AIMB-780QG2-00A1E(Q57 Chipset): supports non-ECC unbuffered DIMMs and do not support any memory configuration that mixes non-ECC with ECC unbuffered DIMMs
- AIMB-780WG2-00A1E(3450 Chipset): supports both ECC and non-ECC unbuffered DIMMs.  
Neither platforms support any memory configuration that mix non-ECC with ECC unbuffered DIMMs.

### 1.3.3 Input/Output

- **PCIe slot:** 1 PCIe x16 expansion slot, 1 PCIe x4 expansion slot, and 1 PCIe x1 expansion slot
- **PCI Bus:** 4 PCI slots, 32-bit, 33 MHz PCI 2.2 compliant
- **Enhanced parallel port:** Configured to LPT1 or disabled. Standard DB-25 female connector provided. Supports EPP/SPP/ECP
- **Serial port:** Four serial ports, one is RS-232/422/485 with hardware auto-flow control and three are RS-232. Two DB-9 connectors located in rear panel are RS-232
- **Keyboard and PS/2 mouse connector:** Two 6-pin mini-DIN connectors are located on the mounting bracket for easy connection to a PS/2 keyboard and mouse.
- **USB port:** Supports up to 14 USB 2.0 ports with transmission rates up to 480 Mbps

### 1.3.4 Graphics

- *Only dual core CPU, such as Core i5 6XX, Core i3 and Pentium processors have integrated Intel® HD Graphics graphic core, quad core processors do NOT have graphic core and need a discrete graphic card for graphic functions.*
- **Display memory:** 1 GB maximum shared memory with 2 GB and above system memory installed
- **DVI-D:** Up to resolution 1920 x 1200 @ 60 Hz refresh rate
- **CRT:** Up to 2048 x 1536 resolution @ 75 Hz refresh rate

### 1.3.5 Ethernet LAN

- Supports single/dual 10/100/1000Base-T Ethernet port (s) via PCIe x1 bus which provides a 500 MB/s data transmission rate.
- **Interface:** 10/100/1000Base-T
- **Controller:** Intel 82578DM(PHY) for LAN1, Intel 82583V for LAN2

### 1.3.6 Industrial Features

- **Watchdog timer:** Can generate a system reset or NC. The watchdog timer is programmable, with each unit equal to one second or one minute (255 levels)

### 1.3.7 Mechanical and Environmental Specifications

- **Operating temperature:** 0 ~ 60°C (32 ~ 140° F, Depending on CPU)
- **Storage temperature:** -20 ~ 70° C (-4 ~ 158° F)
- **Humidity:** 5 ~ 95% non-condensing
- **Power supply voltage:** +3.3 V, +5 V, ±12 V, 5 V<sub>sb</sub>
- **Power consumption:**  
Maximum: +5 V at 4.23 A, +3.3 V at 0.96 A, +12 V at 3.93 A, +5 V<sub>sb</sub> at 1.18 A, -12 V at 0.01 A (Intel Core i5 660 3.3GHz processor and C state is disable , 4 x 2 GB DDR3 Memory SDRAM)
- **Board size:** 304.8 x 228.6 mm (12" x 9.6")
- **Board weight:** 0.5 kg (1.68 lb)

## 1.4 Jumpers and Connectors

Connectors on the AIMB-780 motherboard link it to external devices such as hard disk drives and a keyboard. In addition, the board has a number of jumpers that are used to configure your system for your application.

The tables below list the function of each of the jumpers and connectors. Later sections in this chapter give instructions on setting jumpers. Chapter 2 gives instructions for connecting external devices to your motherboard.

**Table 1.1: Jumper list**

Label	Function
JCMOS1	CMOS and ME clear
JWDT1	Watchdog reset
PSON1	AT(1-2) / ATX(2-3)
JSETCOM3	COM3 RS-232/422/485 Jumper Setting

**Table 1.2: Connectors**

Label	Function
FDD1	FDD connector
LPT1	Parallel port, parallel port x 1, supports SPP/EPP/ECP mode
LAN1_USB12	LAN1 / USB port 1, 2
LAN2_USB34	LAN2 / USB port 3, 4
VGA1	VGA connector
DVI	DVI connector
COM1/COM2/COM4	Serial port: RS-232
COM3	Serial port: COM3; RS-232/422/485 (9-pin connector)
KBMS1	PS/2 keyboard and mouse connector
KBMS2	External keyboard connector (6-pin)
JIR1	Infrared connector
	Keyboard lock and power LED
	Suspend: fast flash (ATX/AT)
JFP3	System On: on (ATX/AT)
	System Off: off (AT)
	System Off: slow flash (ATX)
JFP2	External speaker / SATA HDD LED connector / SM Bus connector
JFP1	Power switch / reset connector
JCASE1	Case open
VOLT1	Voltage display
	HW monitor
JOBS1	Close: enable OBS alarm
	Open: disable OBS alarm
CPUFAN1	CPU fan connector (4-pin)
SYSFAN1	System fan connector (4-pin)
SYSFAN2	System fan connector (4-pin)
LANLED1	LAN1/2 LED extension connector
AUDIO1	Audio connector
FPAUO1	HD audio front panel pin header
USB56	USB port 5, 6



**Table 1.2: Connectors**

<b>Label</b>	<b>Function</b>
USB78	USB port 7, 8
USB910	USB port 9, 10
USB1112	USB port 11,12
USB1314	USB port 13,14
SATA1	Serial ATA1
SATA2	Serial ATA2
SATA3	Serial ATA3
SATA4	Serial ATA4
SATA5	Serial ATA5
SATA6	Serial ATA6
ATX12V1	ATX 12 V auxiliary power connector (for CPU)
EATXPWR1	ATX 24-pin main power connector (for system)
PCIEX16_1	PCIe x16 slot 1
PCIEX4_1	PCIe x4 slot 1
PCIEX1_1	PCIe x1 slot 1
PCI1	PCI slot 1
PCI2	PCI slot 2
PCI3	PCI slot 3
PCI4	PCI slot 4
DIMMA1	Channel A DIMM1
DIMMA2	Channel A DIMM2
DIMMB1	Channel B DIMM1
DIMMB2	Channel B DIMM2
SPI_CN1	Update BIOS pin header
SPDIF_OUT1	SPDIF Audio out pin header

# 1.5 Board Layout: Jumper and Connector Locations

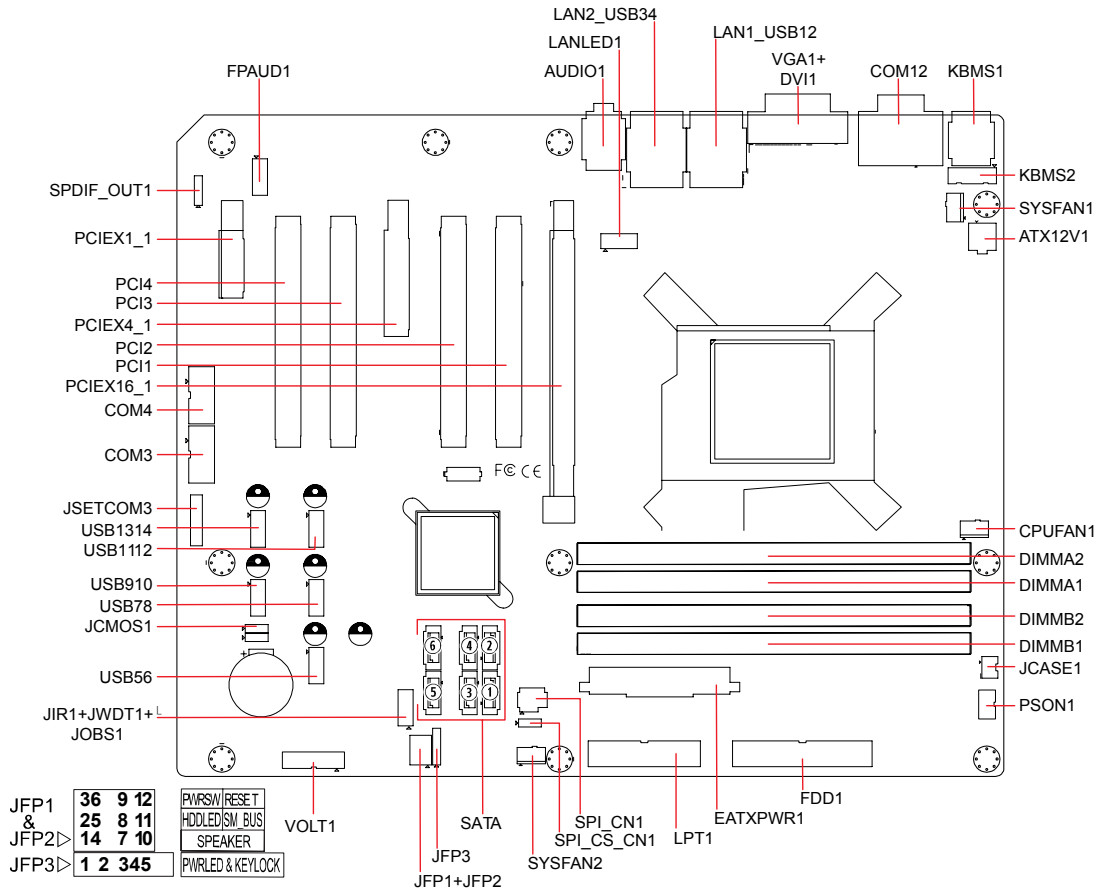

Figure 1.1 Jumper and Connector Locations



Figure 1.2 I/O connectors

## 1.6 AIMB-780 Block Diagram

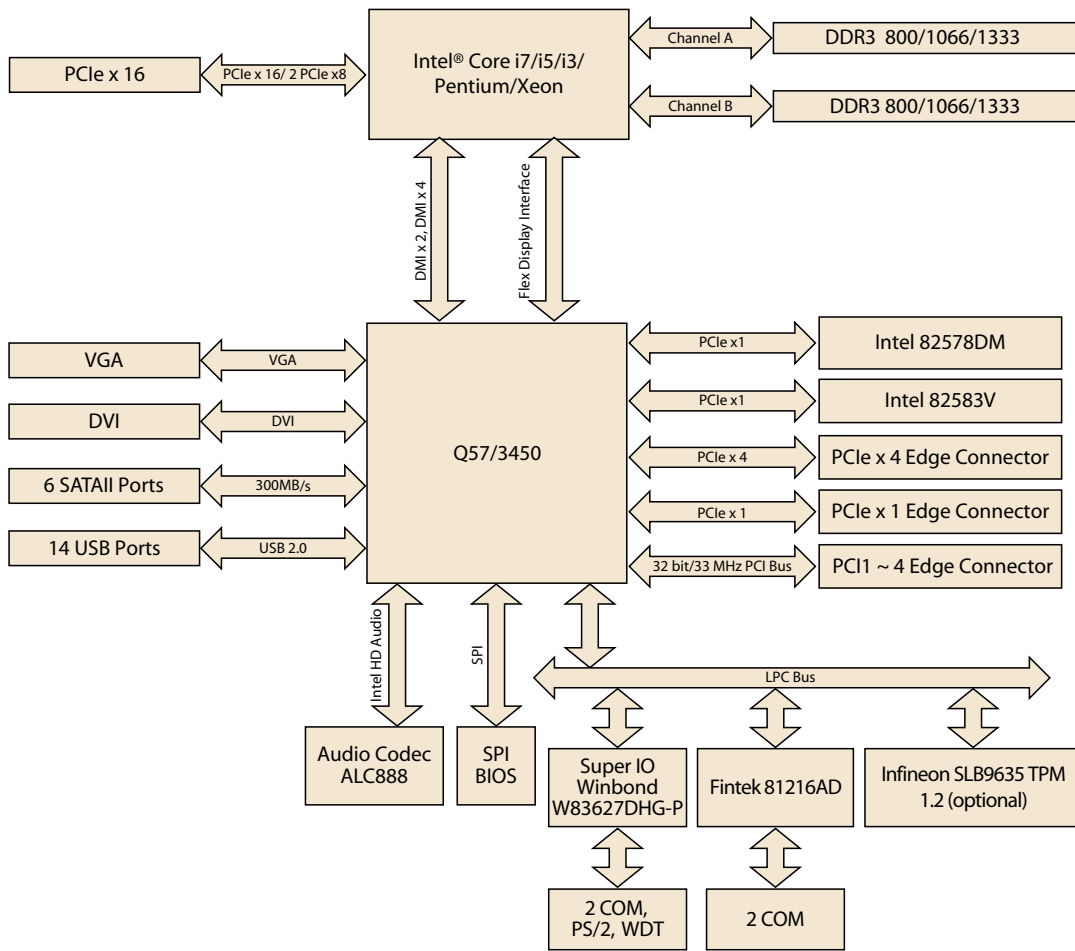

Figure 1.3 AIMB-780 Block Diagram

---

## 1.7 Safety Precautions

**Warning!** *Always completely disconnect the power cord from your chassis whenever you work with the hardware. Do not make connections while the power is on. Sensitive electronic components can be damaged by sudden power surges. Only experienced electronics personnel should open the PC chassis.*



**Caution!** *Always ground yourself to remove any static charge before touching the motherboard. Modern electronic devices are very sensitive to static electric charges. As a safety precaution, use a grounding wrist strap at all times. Place all electronic components on a static-dissipative surface or in a static-shielded bag when they are not in the chassis.*



**Caution!** *The computer is provided with a battery-powered Real-time Clock circuit. There is a danger of explosion if battery is incorrectly replaced. Replace only with same or equivalent type recommended by the manufacturer. Discard used batteries according to manufacturer's instructions.*



**Caution!** *There is a danger of a new battery exploding if it is incorrectly installed. Do not attempt to recharge, force open, or heat the battery. Replace the battery only with the same or equivalent type recommended by the manufacturer. Discard used batteries according to the manufacturer's instructions.*



## 1.8 Jumper Settings

This section provides instructions on how to configure your motherboard by setting the jumpers. It also includes the motherboard default settings and your options for each jumper.

### 1.8.1 How to set jumpers

You can configure your motherboard to match the needs of your application by setting the jumpers. A jumper is a metal bridge that closes an electrical circuit. It consists of two metal pins and a small metal clip (often protected by a plastic cover) that slides over the pins to connect them. To “close” (or turn on) a jumper, you connect the pins with the clip. To “open” (or turn off) a jumper, you remove the clip. Sometimes a jumper consists of a set of three pins, labeled 1, 2, and 3. In this case you connect either pins 1 and 2, or 2 and 3. A pair of needle-nose pliers may be useful when setting jumpers.

### 1.8.2 CMOS clear (JCMOS1)

The AIMB-780 motherboard contains a jumper that can erase CMOS data and reset the system BIOS information. Normally this jumper should be set with pins 1-2 closed. If you want to reset the CMOS data, set J1 to 2-3 closed for just a few seconds, and then move the jumper back to 1-2 closed. This procedure will reset the CMOS to its default setting.

**Table 1.3: JCMOS1**

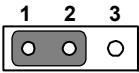
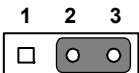
Function	Jumper Setting
* Keep CMOS and ME data	 1-2 closed
Clear CMOS and ME data	 2-3 closed
* default setting	

### 1.8.3 Watchdog timer output (JWDT1)

The AIMB-780 contains a watchdog timer that will reset the CPU. This feature means the AIMB-780 will recover from a software failure or an EMI problem. The JWDT1 jumper settings control the outcome of what the computer will do in the event the watchdog timer is tripped.

**Table 1.4: Watchdog timer output (JWDT1)**

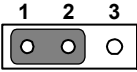
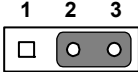
Function	Jumper Setting
NC	 1-2 closed
* Reset	 2-3 closed
* default setting	

**Note!** *The interrupt output of the watchdog timer is a low level signal. It will be held low until the watchdog timer is reset.*

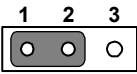
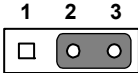
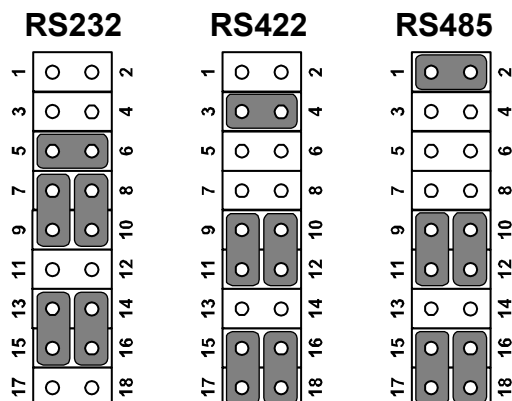

**Table 1.5: ATX/AT mode selector (PSON1)**

Function	Jumper Setting
AT Mode	 1-2 closed
* ATX Mode	 2-3 closed
* default setting	

**Table 1.6: COM3 RS-232/422/485 mode selector (JSETCOM3)**

Use JSETCOM3 to select the RS-232/422/485 mode for COM3. The default setting is RS-232.



## 1.9 System Memory

AIMB-780 has four 240-pin memory sockets for (ECC) DDR3 1066/1333 MHz memory modules with maximum capacity of 16GB (Maximum 4GB for each DIMM).

AIMB-780 QG2 SKU supports non-ECC DDR3 memory modules only.

AIMB-780 WG2 SKU supports ECC and non-ECC DDR3 memory modules.

Please note that AIMB-780 does NOT support registered DIMMs (RDIMMs).

**Note!**  Because AIMB-780 supports Intel Active Management Technology 6.0 (iAMT6.0) which utilizes some memory space of channel 0, it's suggested that the user should not leave channel 0 DIMM slots (DIMMA1 and DIMMA2) empty, or it may cause some system abnormality.

## 1.10 Memory Installation Procedures

To install DIMMs, first make sure the two handles of the DIMM socket are in the “open” position. i.e. The handles lean outward. Slowly slide the DIMM module along the plastic guides on both ends of the socket, and then press the DIMM module right down into the socket, until you hear a click. This is when the two handles have automatically locked the memory module into the correct position of the DIMM socket. To remove the memory module, just push both handles outward, and the memory module will be ejected by the mechanism in the socket.

## 1.11 Cache Memory

The AIMB-780 supports a CPU with one of the following built-in full speed L2 caches: The built-in second-level cache in the processor yields much higher performance than conventional external cache memories.

- 8 MB for Intel Xeon 34xx CPU
- 8 MB for Intel Core i7 CPU
- 8 MB for Intel Core i5-7xx CPU
- 4 MB for Intel Core i5-6xx CPU
- 4 MB for Intel Core i3 CPU
- 3 MB for Intel Pentium CPU

## 1.12 Processor Installation

The AIMB-780 is designed for LGA1156, Intel Core i7/i5/i3/Pentium/Xeon processor.

## 1.13 PCI Bus Routing Table

AD PCI slot INT	PCI1	PCI2	PCI3	PCI4
	<b>31</b>	<b>30</b>	<b>29</b>	<b>28</b>
A	B	C	D	A
B	C	D	A	B
C	D	A	B	C
D	A	B	C	D





# Chapter 2

Connecting  
Peripherals

## 2.1 Introduction

You can access most of the connectors from the top of the board as it is being installed in the chassis. If you have a number of cards installed, you may need to partially remove a card to make all the connections.

## 2.2 Floppy Drive Connector (FDD1)

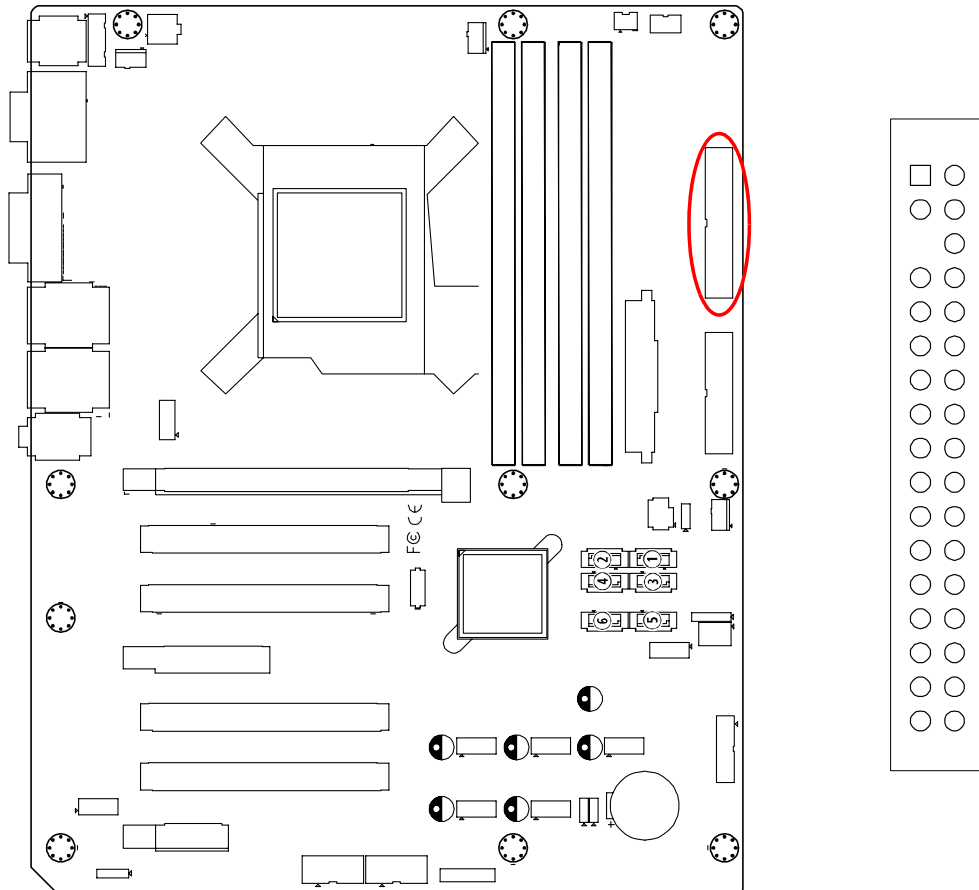

You can attach up to two floppy disk drives to the AIMB-780's onboard controller. You can use 3.5" (720 KB, 1.44 MB) drives.

## 2.3 Parallel Port (LPT1)

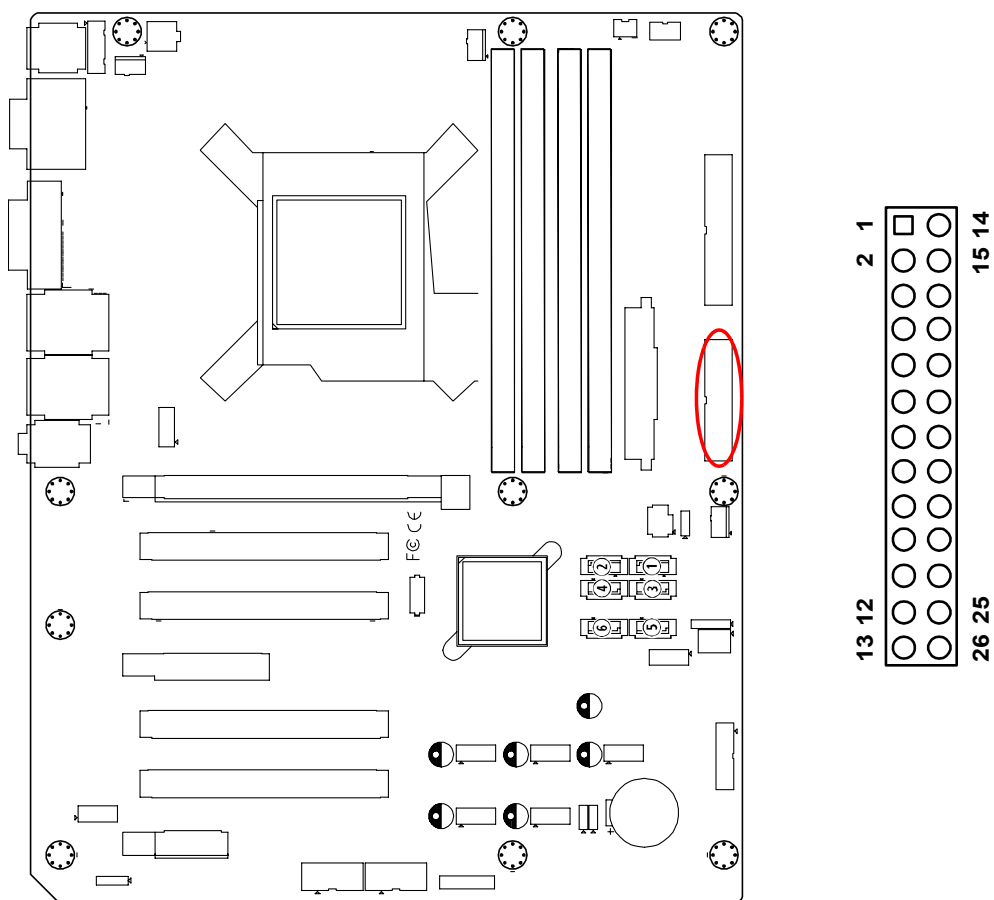

The parallel port is normally used to connect the motherboard to a printer. The AIMB-780 includes an onboard parallel port, accessed through a 25-pin flat-cable connector, LPT1.

## 2.4 USB Ports (LAN1\_USB12, LAN2\_USB3/4, USB5/6, USB7/8, USB9/10, USB11/12 & USB13/14)

These ports support Plug & Play and hot swapping for up to 127 external devices. The USB ports comply with USB specification rev. 2.0. Transmission rates of up to 480 Mbps and fuse protection are supported. The USB interface can be disabled in the system BIOS setup.

The AIMB-780 is equipped with one or two high-performance 1000 Mbps Ethernet LANs. They are supported by all major network operating systems. The RJ-45 jacks on the rear plate provide convenient 1000Base-T operation.

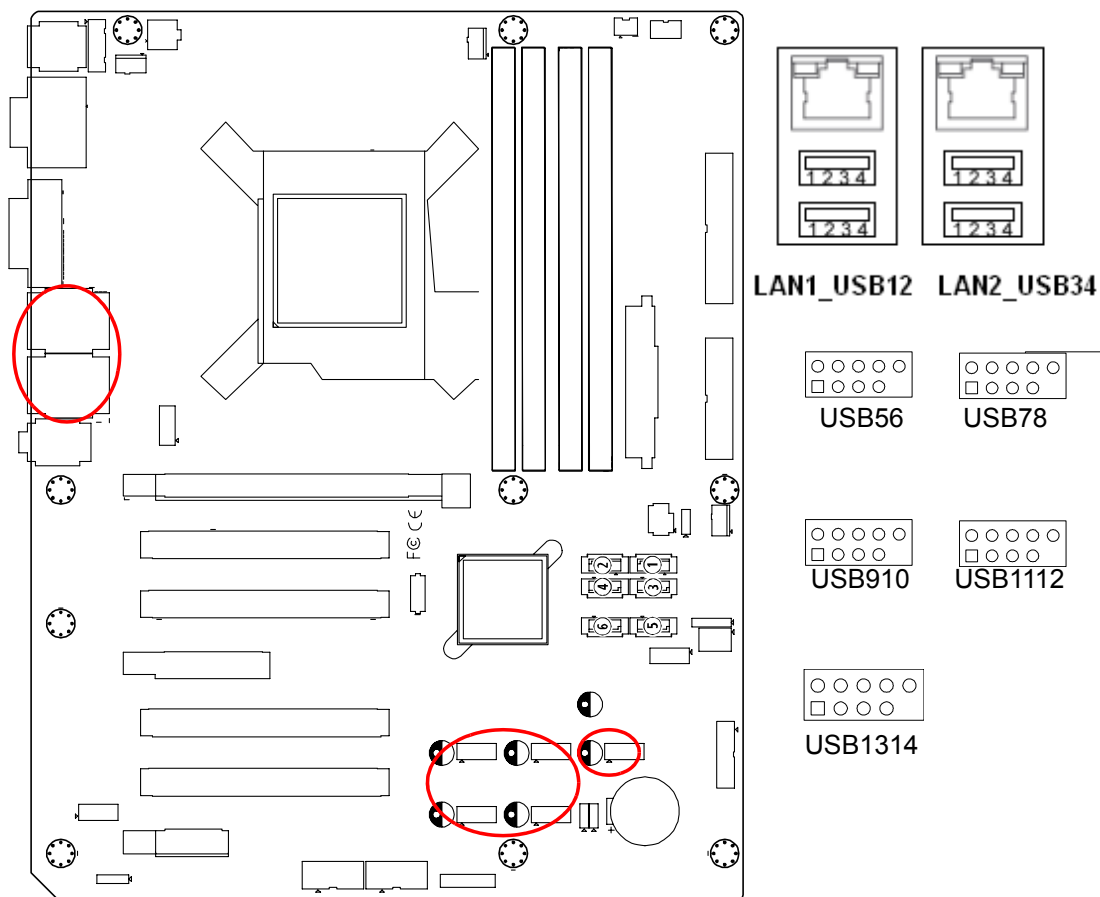

## 2.5 VGA Connector and DVI-D Connector (VGA1+DVI1)

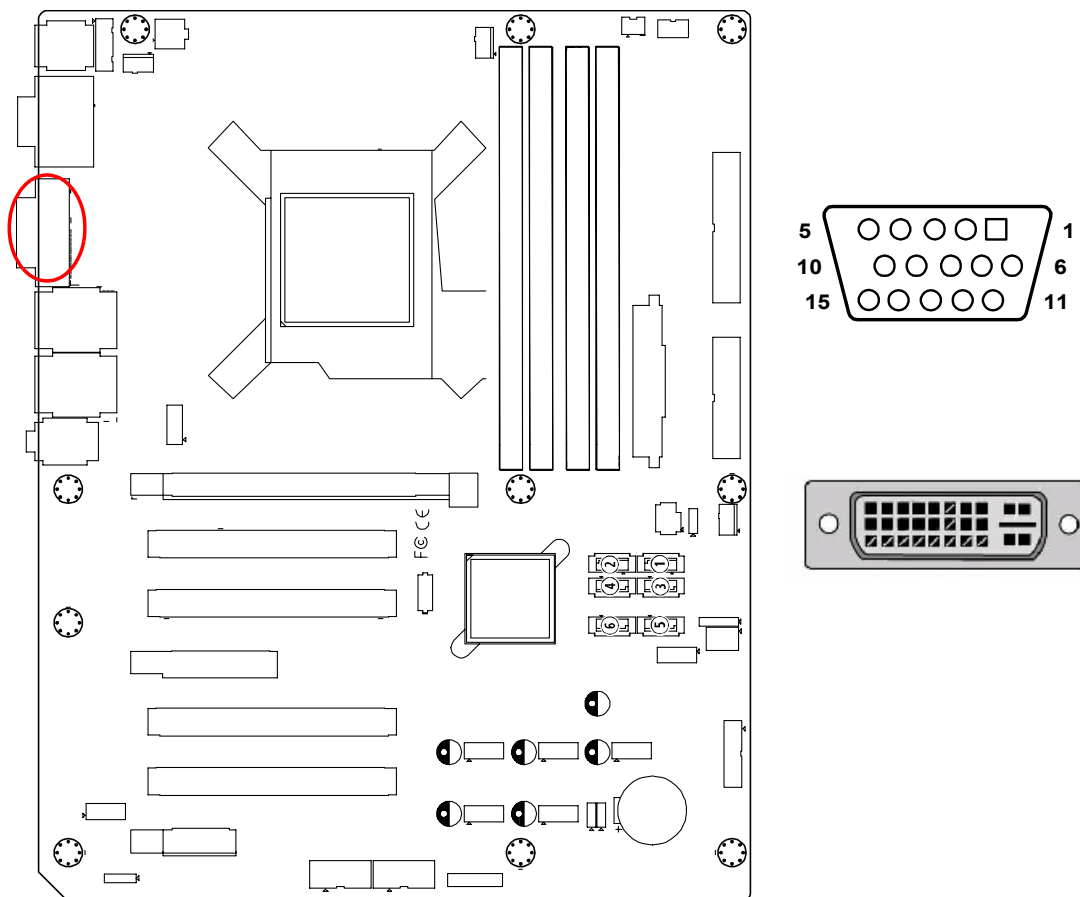

The AIMB-780 includes both VGA and DVI-D interface that can drive conventional CRT and LCD displays. Pin assignments of VGA1 and DVI1 are detailed in Appendix B.

## 2.6 Serial Ports (COM1, COM2, COM3 & COM4)

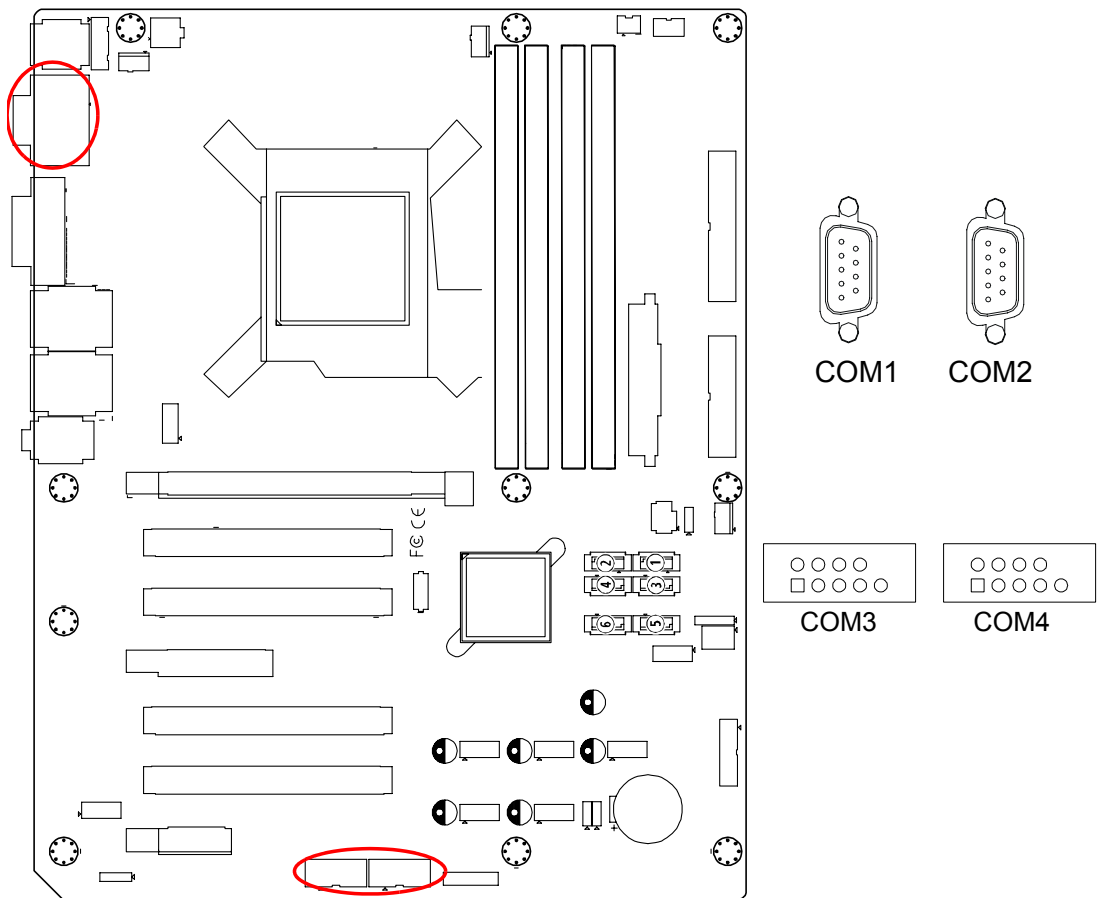

The AIMB-780 offers four serial ports (two on the rear panel and two onboard). JSETCOM3 is used to select the RS 232/422/485 mode for COM3. These ports can connect to a serial mouse, printer or communications network. The IRQ and address ranges for both ports are fixed. However, if you want to disable the port or change these parameters later, you can do this in the system BIOS setup. Different devices implement the RS-232/422/485 standards in different ways. If you are having problems with a serial device, be sure to check the pin assignments for the connector.

## 2.7 PS/2 Keyboard and Mouse Connector (KBMS1)

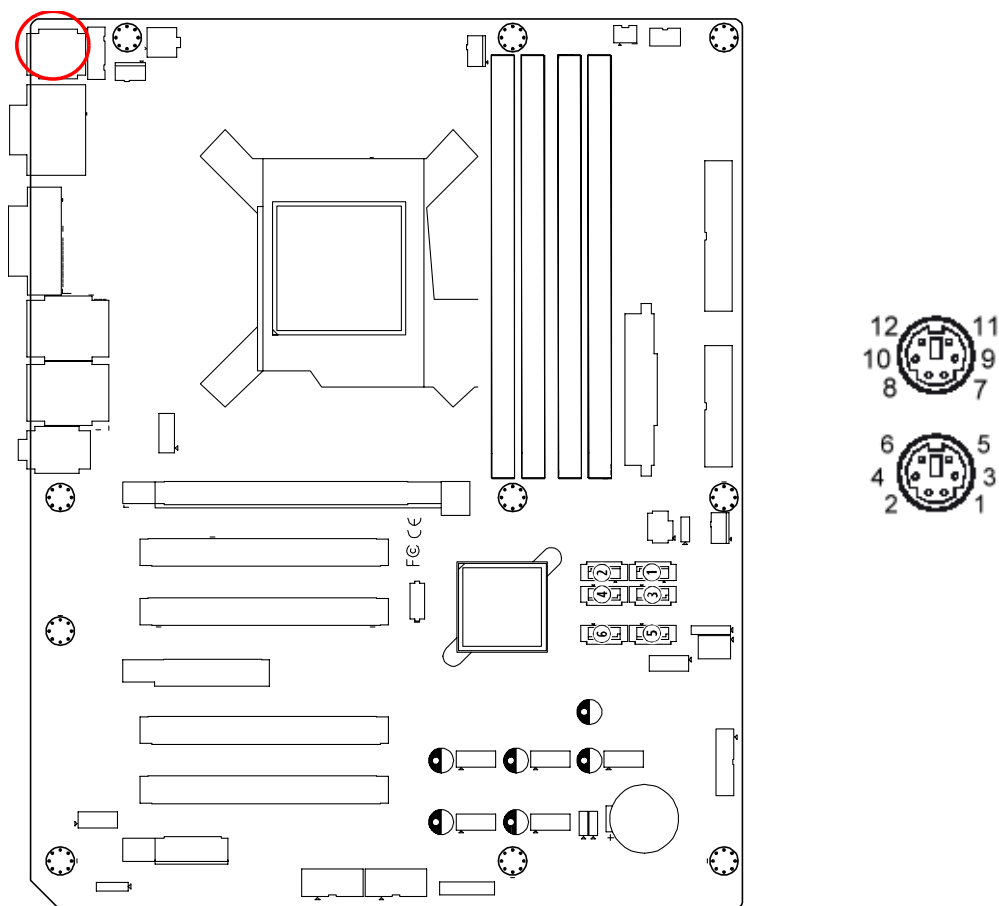

Two 6-pin mini-DIN connectors (KBMS1) on the rear panel of the motherboard provide PS/2 keyboard and mouse connections.

## 2.8 External Keyboard & Mouse (KBMS2)

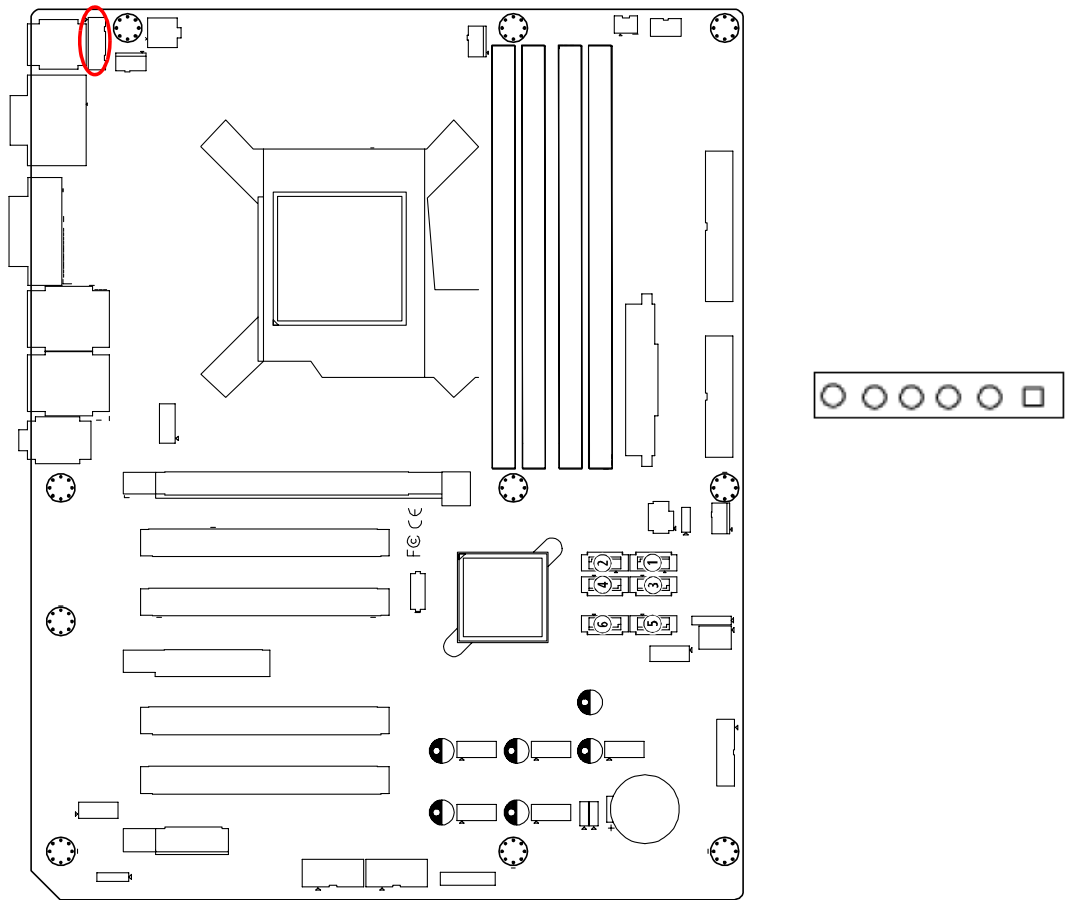

There is also an extra onboard external keyboard and mouse connector on the motherboard. This gives system integrators greater flexibility in designing their systems.



## 2.9 CPU Fan Connector (CPUFAN1)

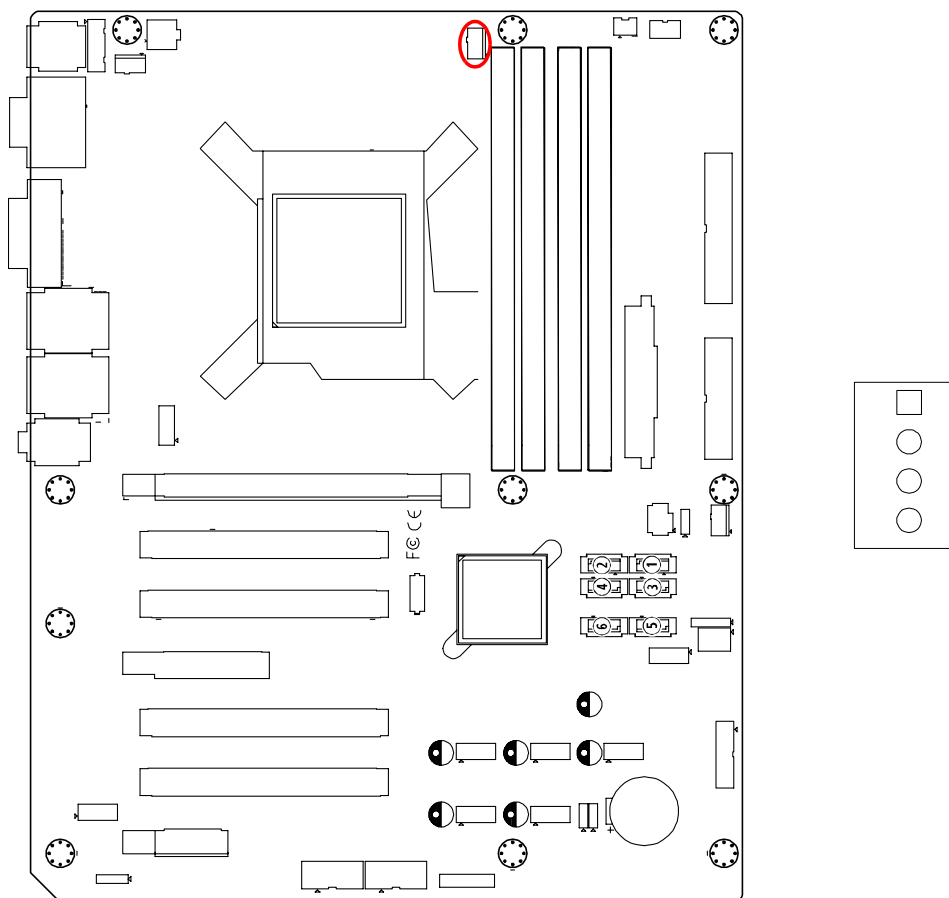

If a fan is used, this connector supports cooling fans that draw up to 500 mA (6 W).

## 2.10 System FAN Connector (SYSFAN1 and SYSFAN2)

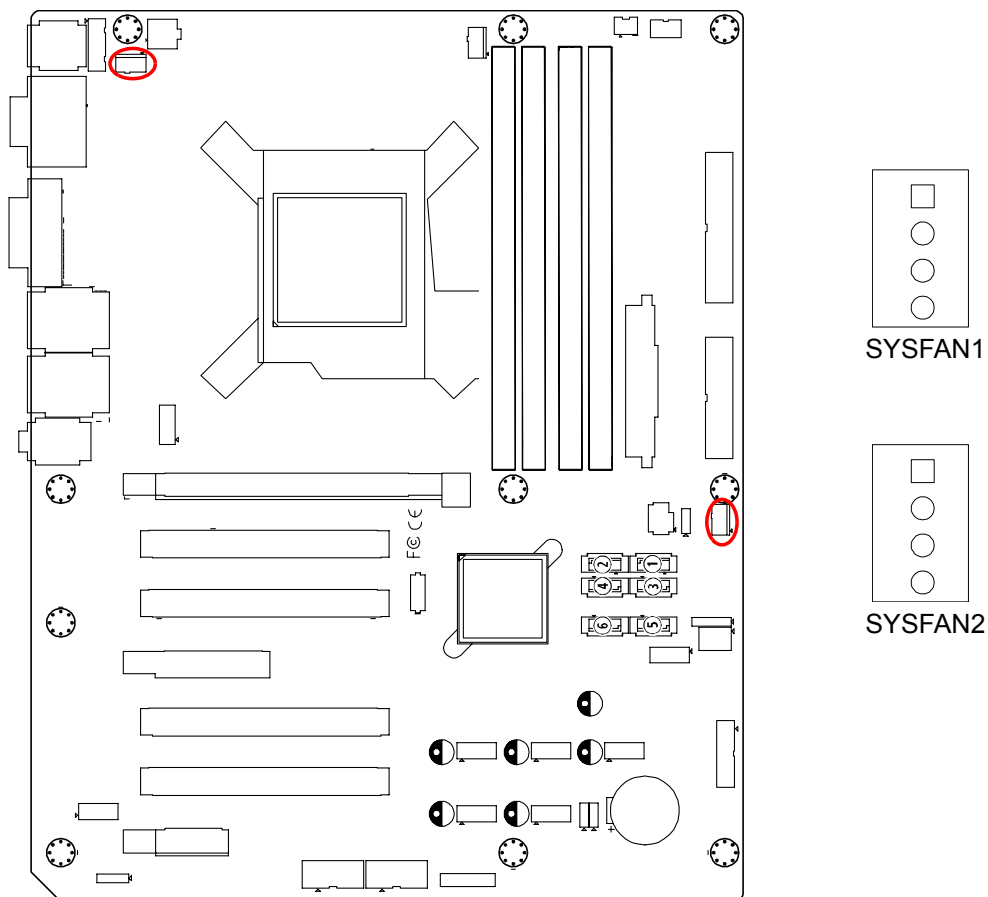

If a fan is used, this connector supports cooling fans that draw up to 500 mA (6 W).

## 2.11 Front Panel Connectors (JFP1, JFP2 & JFP3)

There are several external switches and LEDs to monitor and control the AIMB-780.

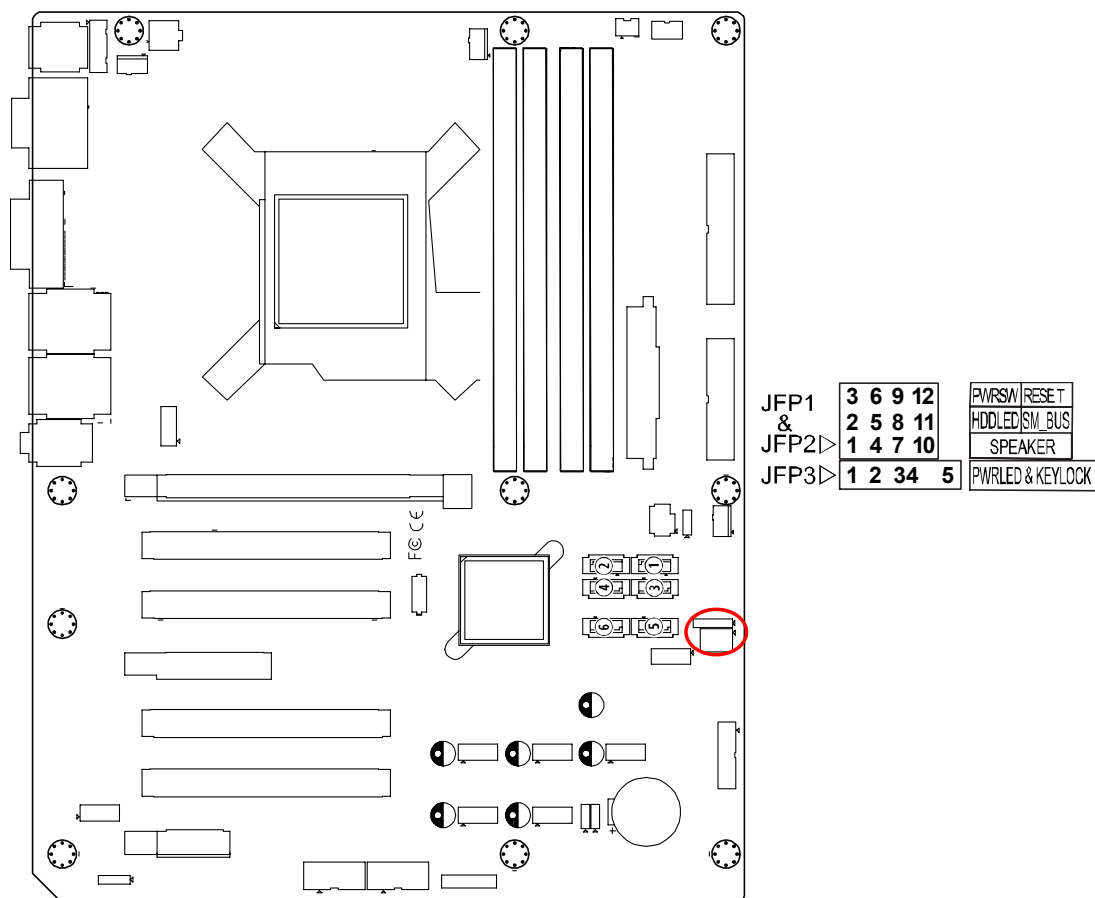

### 2.11.1 Power LED and Keyboard Lock (JFP3)

JFP3 is a 5-pin connector for the power LED. Refer to Appendix B for detailed information on the pin assignments. If a PS/2 or ATX power supply is used, the system's power LED status will be as indicated as follows.

**Table 2.1: PS/2 or ATX power supply LED status**

Power mode	LED (PS/2 power)	LED (ATX power)
System On	On	On
System Suspend	Fast flashes	Fast flashes
System Off	Off	Slow flashes

### 2.11.2 External Speaker (JFP2 pins 1, 4, 7 & 10)

JFP2 is a 8-pin connector for an external speaker. The AIMB-780 provides an onboard buzzer as an alternative. To enable the buzzer, set pins 5-7 as closed.

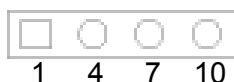

### 2.11.3 HDD LED Connector (JFP2 pins 2 & 5)

You can connect an LED to connector JFP2 to indicate when the HDD is active.

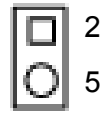

### 2.11.4 ATX Soft Power Switch (JFP1 pins 3 & 6)

If your computer case is equipped with an ATX power supply, you should connect the power on/off button on your computer case to pins 3 and 6 of JFP1. This connection enables you to turn your computer on and off.

### 2.11.5 Reset Connector (JFP1 pins 9 & 12)

Many computer cases offer the convenience of a reset button.

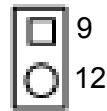

## 2.12 Line Out, Mic In Connector (AUDIO1)

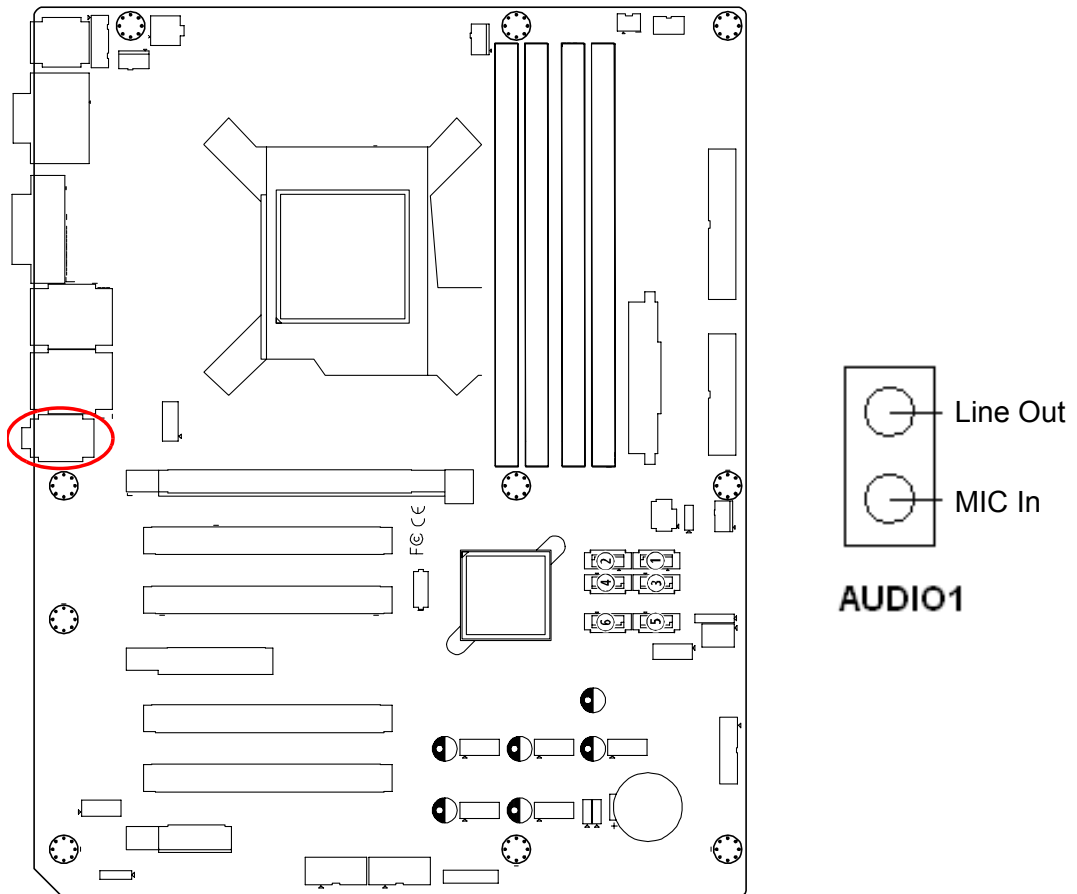

Line Out can be connected to external audio devices like speakers or headphones.  
Mic In can be connected to a microphone.

## 2.13 8-pin Alarm Board Connector (VOLT1)

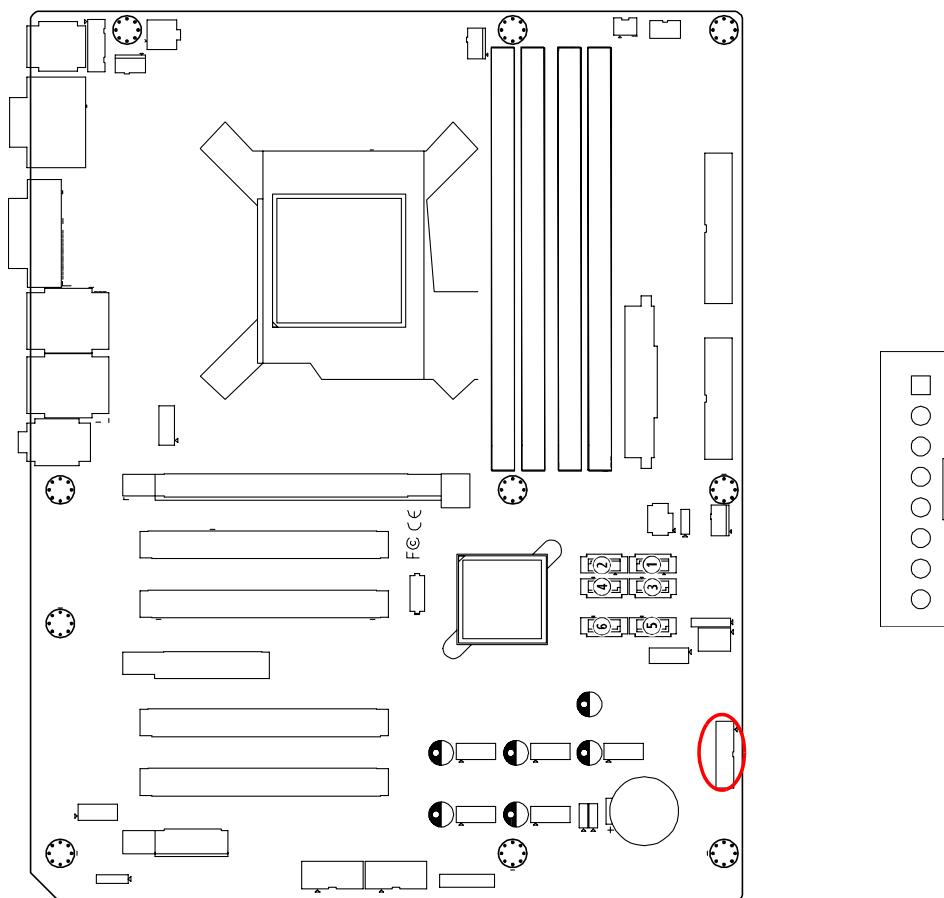

VOLT1 connects to the alarm board of Advantech chassis. These alarm boards give warnings if a power supply or fan fails; if the chassis overheats; or if the backplane malfunctions.

## 2.14 Case Open Connector (JCASE1)

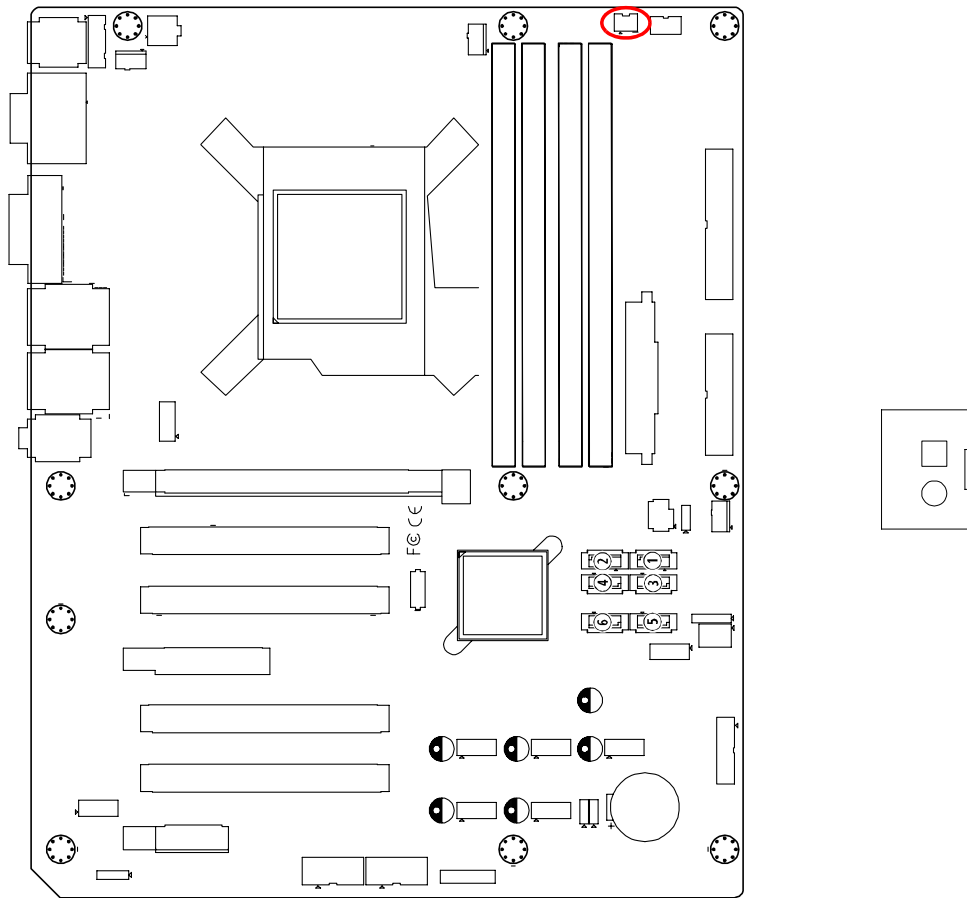

JCASE1 is for chassis with a case open sensor. The buzzer on the motherboard sounds if the case is opened.

## 2.15 Front Panel LAN Indicator Connector (LAN\_LED1)

Table 2.2: Front Panel LAN Indicator Connector

LAN Mode	Indicator
G-LAN Link ON	Green ON
G-LAN Active	Green Flash
G-LAN Link Off	Green OFF

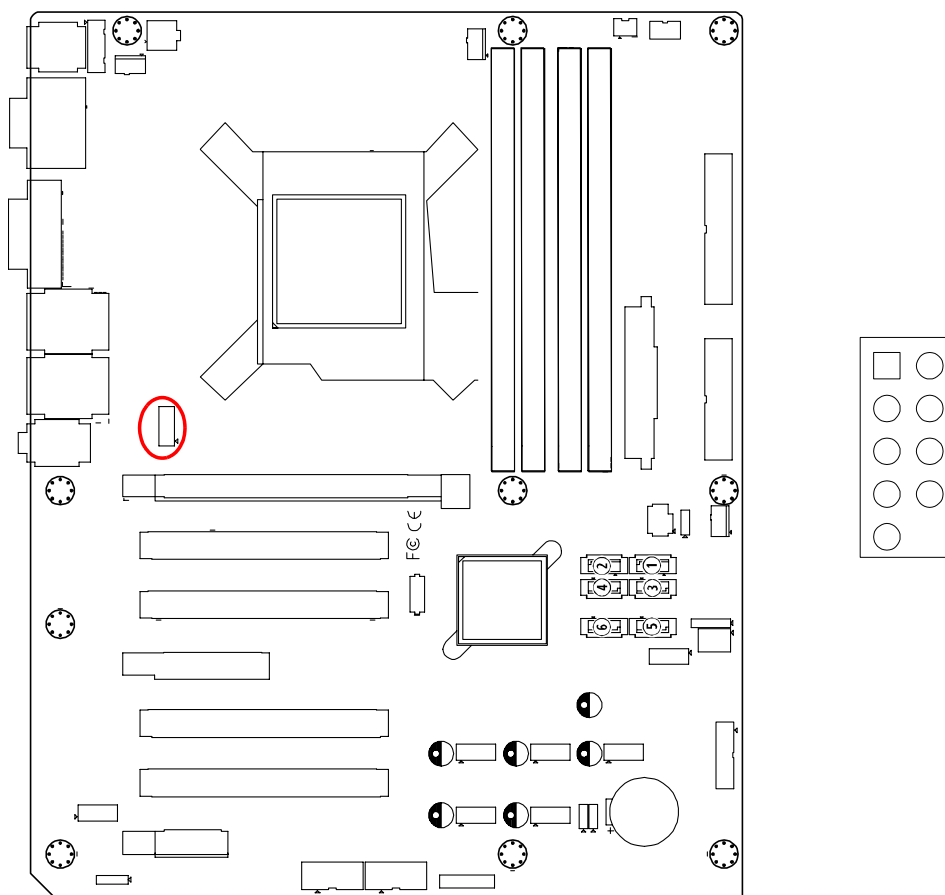

## 2.16 Serial ATA Interface (SATA1, SATA2, SATA3, SATA4, SATA5 & SATA6)

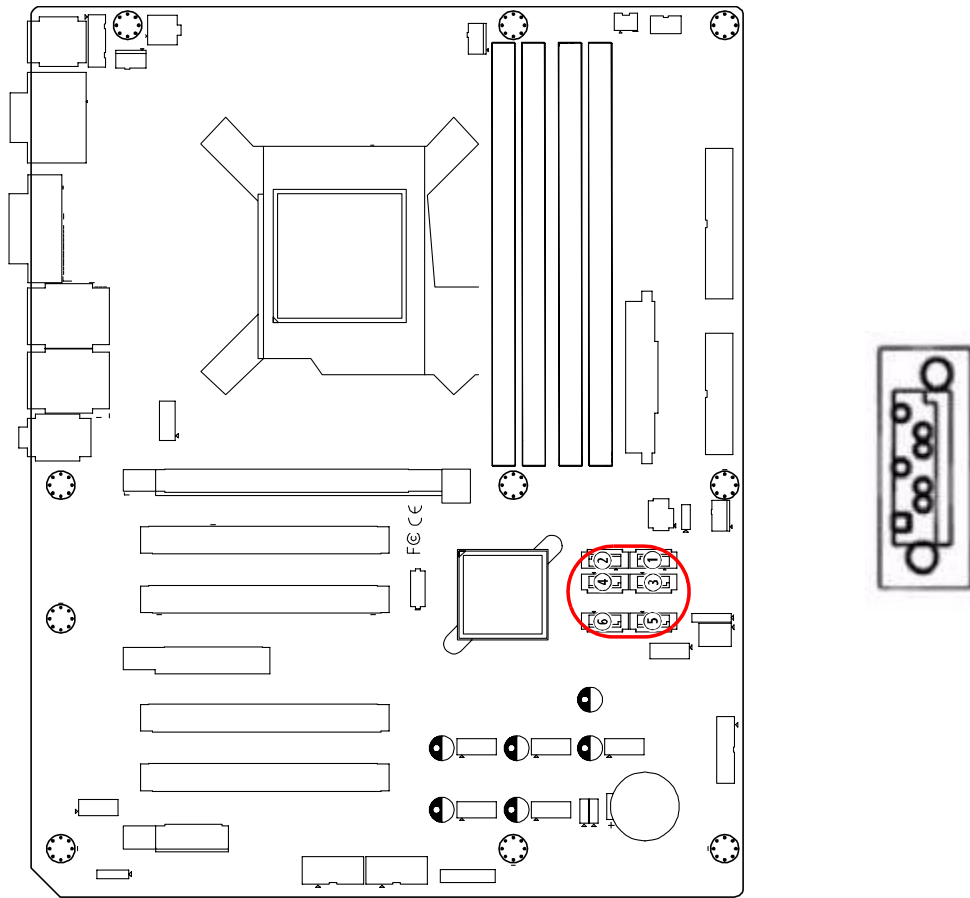

AIMB-780 features six high performance serial ATA interface (up to 300 MB/s) which eases cabling to hard drives with thin and long cables.



## 2.17 PCI Slots (PCI 1 ~ PCI 4)

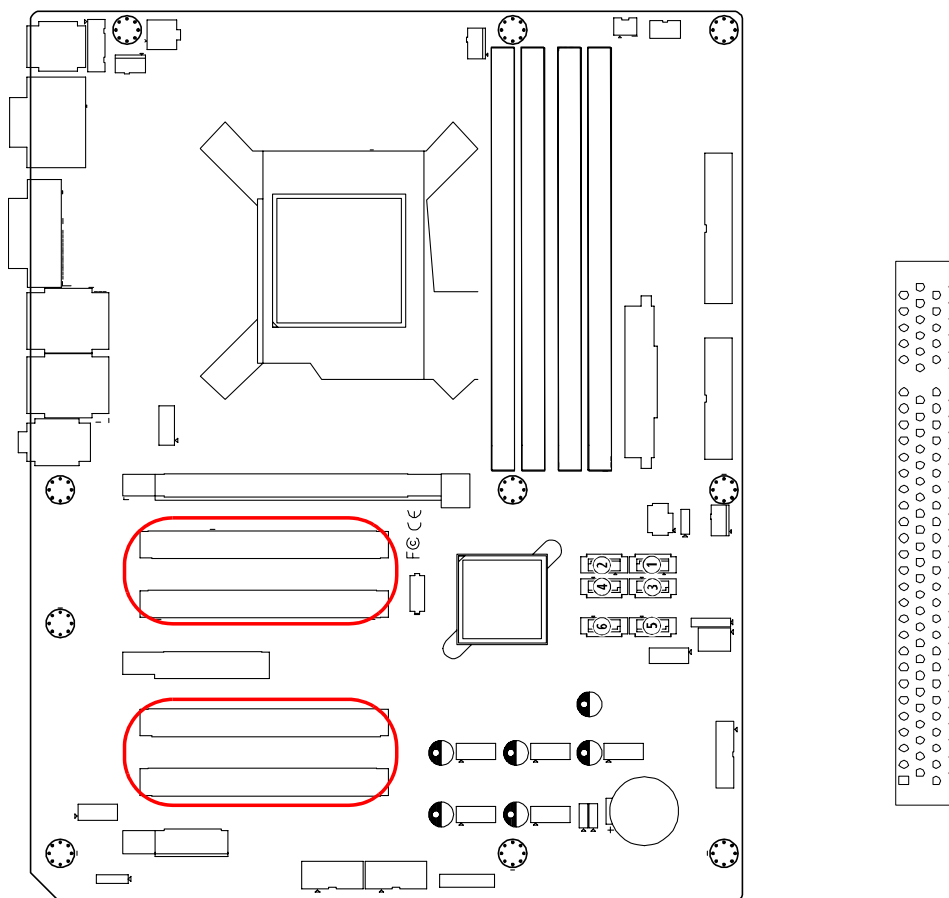

The AIMB-780 provides four 32-bit / 33 MHz PCI slots.

**Note!** *64-bit PCI or PCI-X expansion cards installed in the PCI 2 slots will not fit because of the south bridge heat sink. If you want to use 64-bit PCI or PCI-X expansion cards, please install them in the PCI 1, PCI 3 or PCI 4.*



## 2.18 PCIe x16 Expansion Slot (PCIEX16\_1)

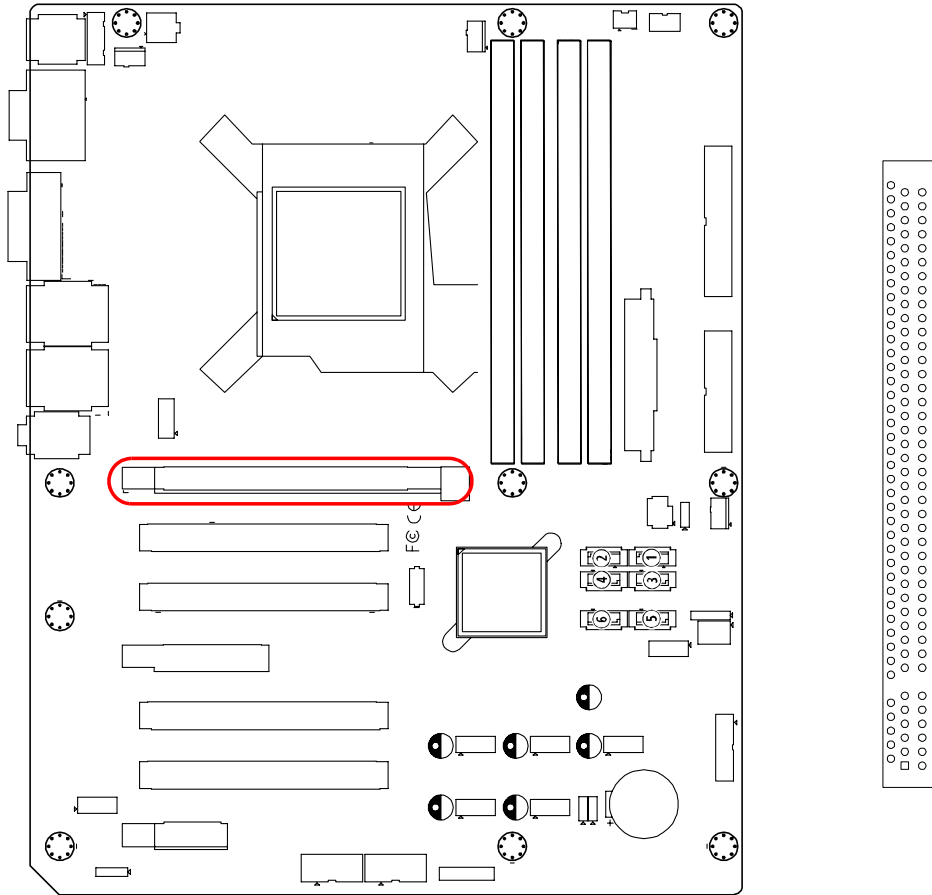

The AIMB-780 provides a PCIe x16 slot for users to install add-on VGA cards when their applications require higher graphics performance than the CPU embedded graphics controller can provide.

## 2.19 PCIEX4\_1

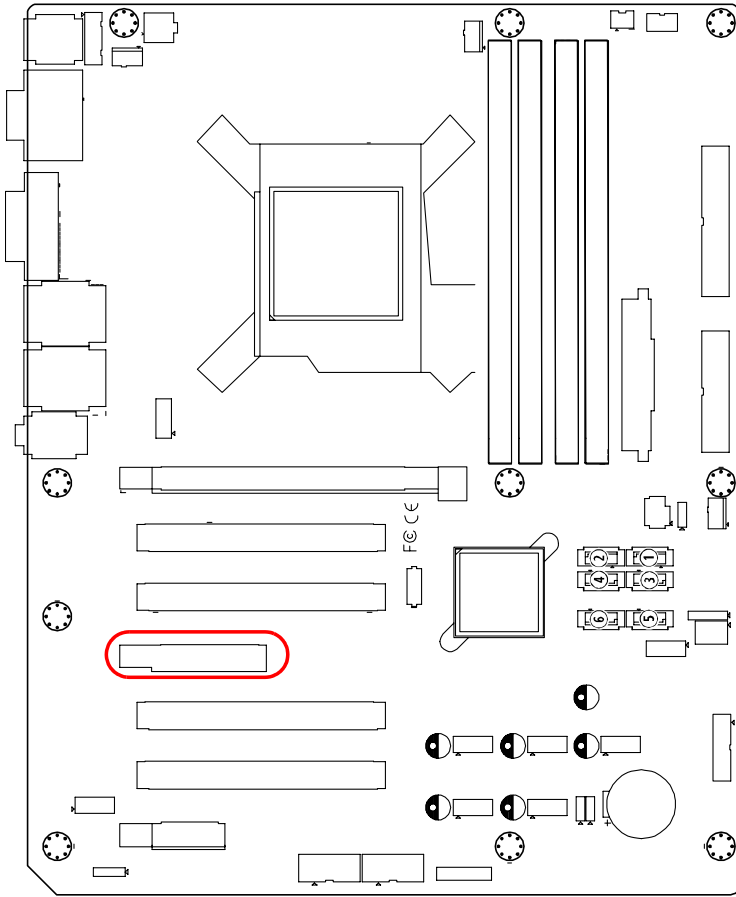

## 2.20 PCIEX1\_1

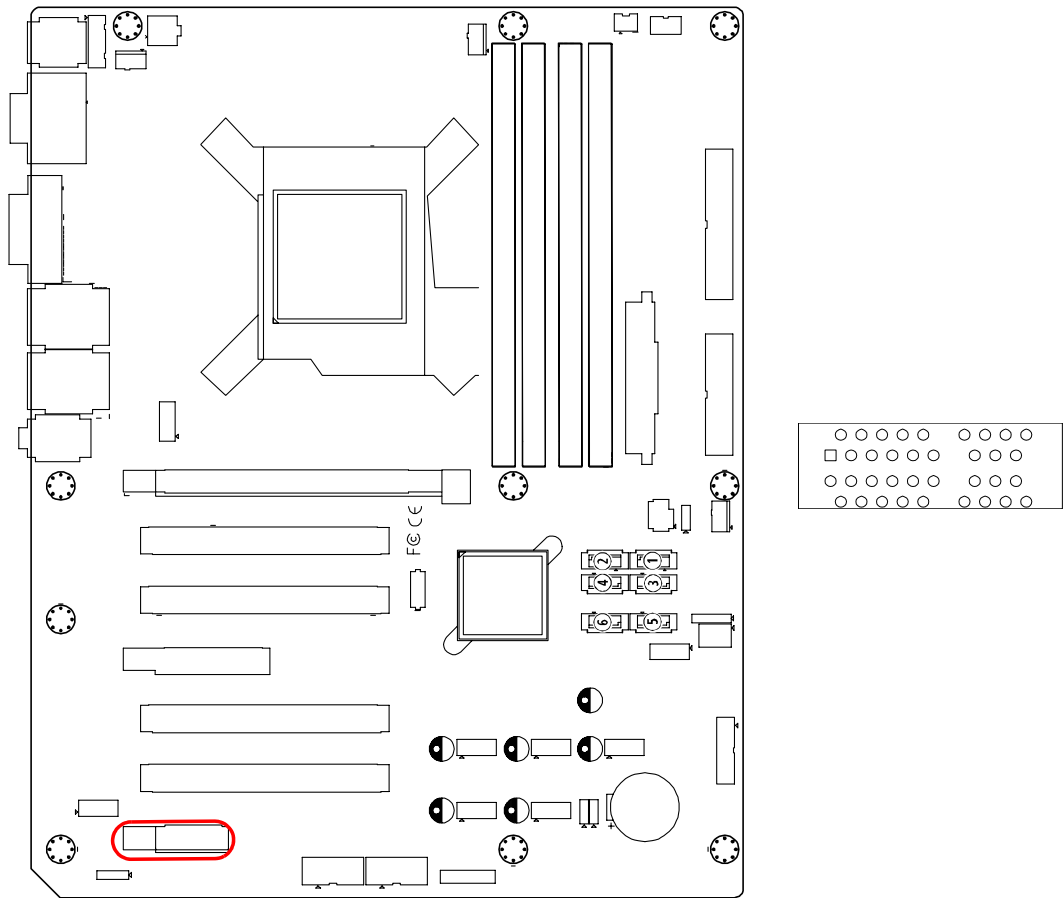

## 2.21 Auxiliary 4-pin power connector (ATX12V1)

To ensure the enough power is supplied to the motherboard, one auxiliary 4-pin power connector is available on the AIMB-780. ATX1 must be used to provide sufficient 12 V power to ensure the stable operation of the system.

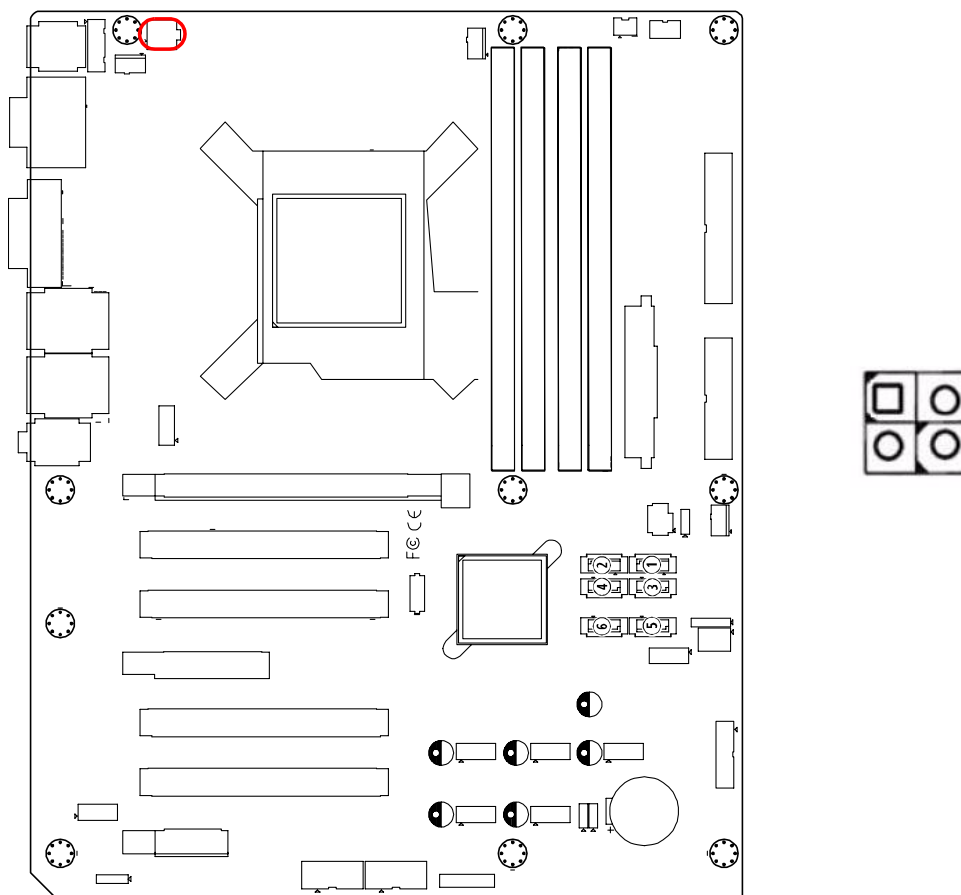

## 2.22 SPI Flash connector(SPI\_CN1)

SPI flash card pin header which can flash BIOS while AIMB-780 can not be power on and ensures platform integrity.



# Chapter 3

BIOS Operation

## 3.1 Introduction

AMIBIOS has been integrated into many motherboards for over a decade. In the past, people often referred to the AMIBIOS setup menu as BIOS, BIOS setup or CMOS setup.

With the AMIBIOS Setup program, you can modify BIOS settings and control the special features of your computer. The Setup program uses a number of menus for making changes and turning the special features on or off. This chapter describes the basic navigation of the AIMB-780 setup screens.

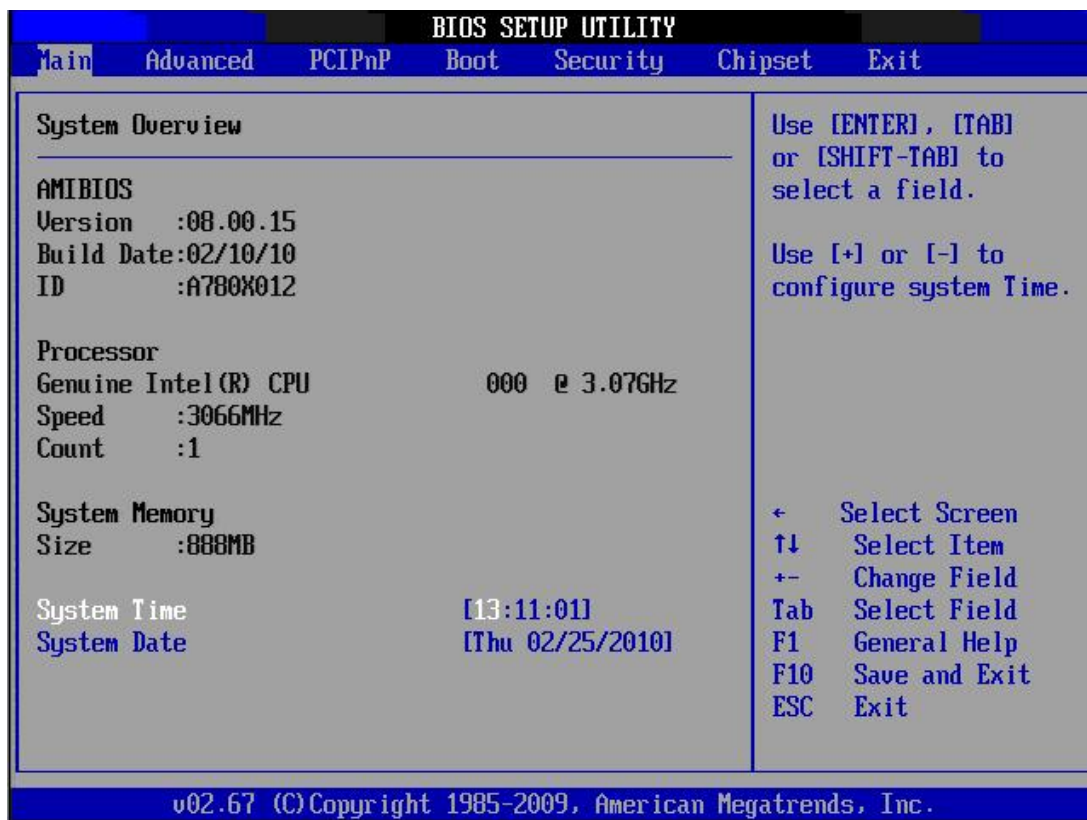

**Figure 3.1 Main setup screen**

AMI's BIOS ROM has a built-in Setup program that allows users to modify the basic system configuration. This type of information is stored in battery-backed up CMOS so it retains the Setup information when the power is turned off.



## 3.2 Main Menu

Press <Del> to enter AMI BIOS CMOS Setup Utility, the Main Menu will appear on the screen. Use arrow keys to select among the items and press <Enter> to accept or enter the sub-menu.

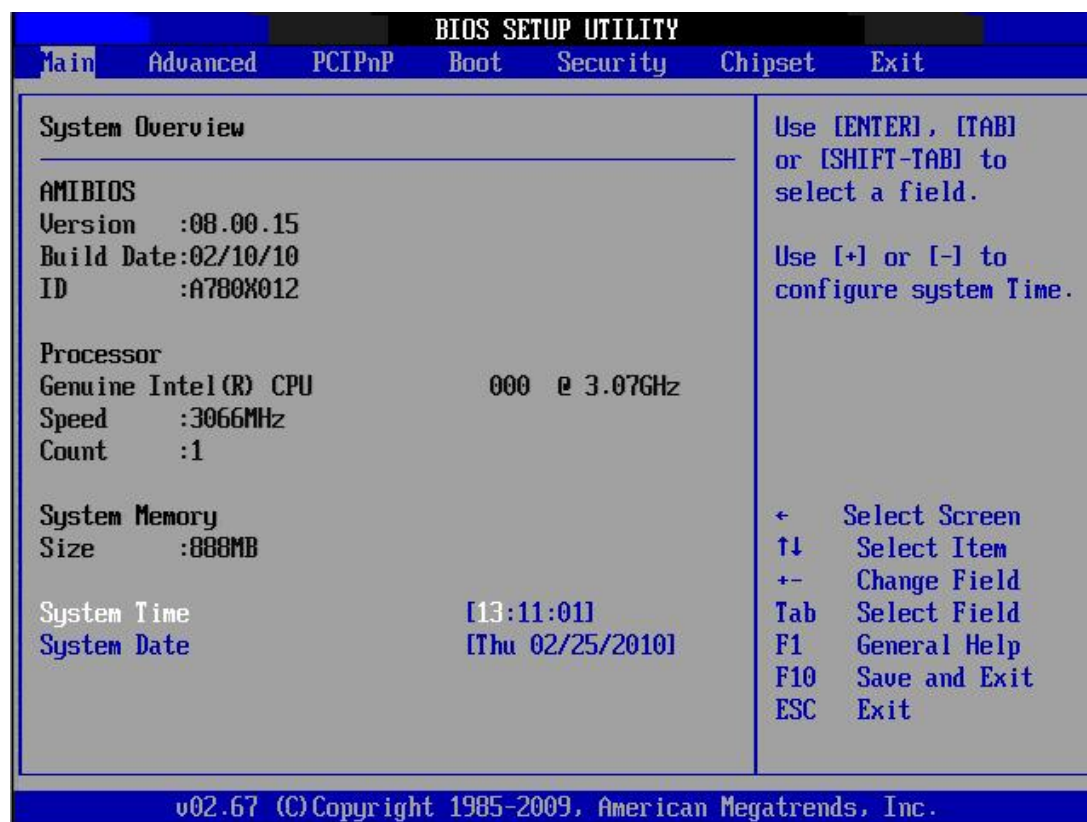

**Figure 3.2 Main setup screen**

The Main BIOS setup screen has two main frames. The left frame displays all the options that can be configured. Grayed-out options cannot be configured; options in blue can be. The right frame displays the key legend.

Above the key legend is an area reserved for a text message. When an option is selected in the left frame, it is highlighted in white. Often a text message will accompany it.

### 3.2.1 System time / System date

Use this option to change the system time and date. Highlight System Time or System Date using the <Arrow> keys. Enter new values through the keyboard. Press the <Tab> key or the <Arrow> keys to move between fields. The date must be entered in MM/DD/YY format. The time must be entered in HH:MM:SS format.

### 3.3 Advanced BIOS Features Setup

Select the Advanced tab from the AIMB-780 setup screen to enter the Advanced BIOS setup screen. You can select any of the items in the left frame of the screen, such as CPU configuration, to go to the sub menu for that item. You can display an Advanced BIOS Setup option by highlighting it using the <Arrow> keys. All Advanced BIOS Setup options are described in this section. The Advanced BIOS Setup screens are shown below. The sub menus are described on the following pages.

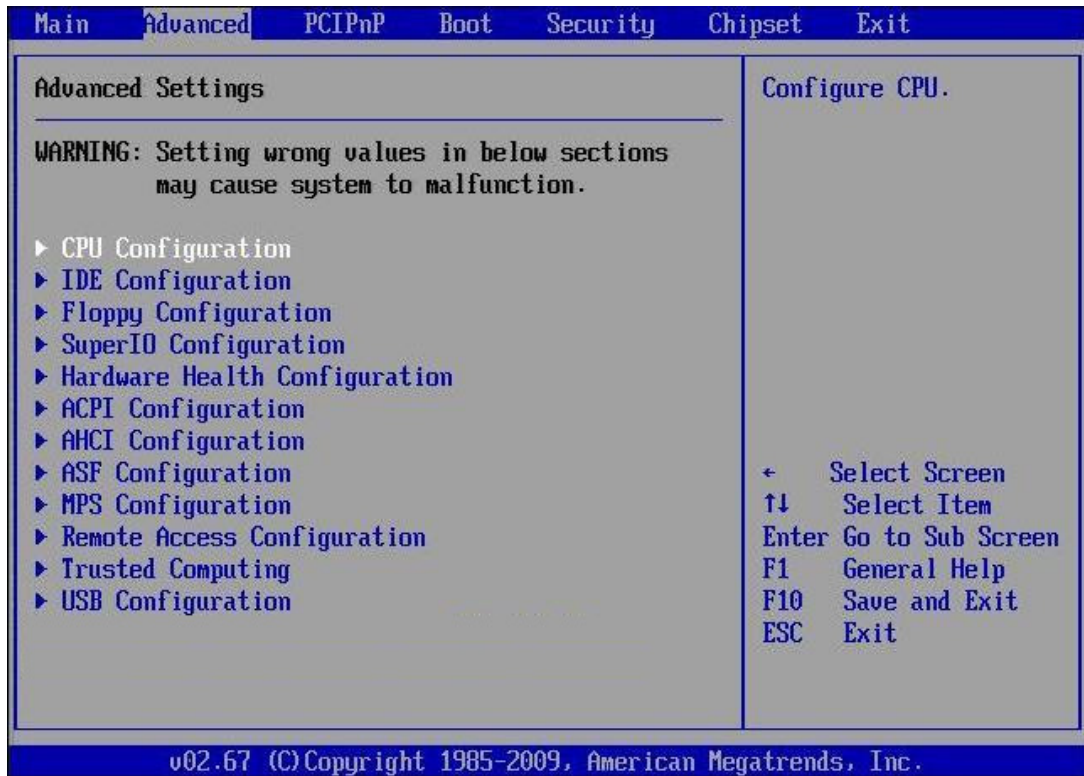

Figure 3.3 Advanced BIOS features setup screen

### 3.3.1 CPU Configuration

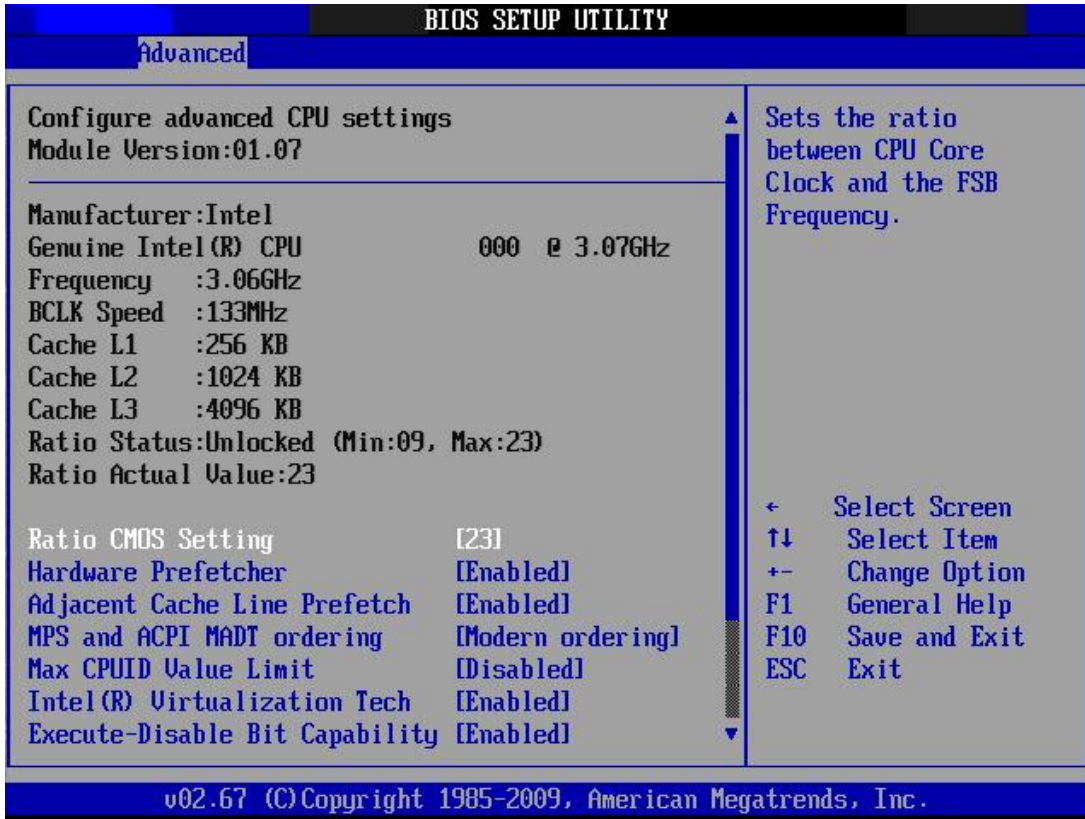

Figure 3.4 CPU Configuration Setting (1)



Figure 3.5 CPU Configuration Setting (2)

---

### **Ration CMOS Setting**

Allows you to set the ratio between the CPU Core Clock and the BCLK Frequency. The valid value ranges vary according to your CPU model.

### **Hardware Prefetcher**

Hardware Prefetcher is a technique that fetches instructions and/or data from memory into the CPU cache memory well before the CPU needs it, so that it can improve the load-to-use latency. You may choose to enable or disable it.

### **Adjacent Cache Line Prefetch**

The processor fetches the currently requested cache line, as well as the subsequent cache line. This reduces the cache latency by making the next cache line immediately available if the processor requires it as well.

### **MPS and ACPI MADT ordering**

MADT refers to Multiple APIC Description Table.

### **Max CPUID Value Limit**

This item allows you to limit CPUID maximum value.

### **Intel® Virtualization Tech**

Intel Virtualization Technology (Intel VT) is a set of hardware enhancements to Intel server and client platforms that provide software-based virtualization solutions. Intel VT allows a platform to run multiple operating systems and applications in independent partitions, allowing one computer system to function as multiple virtual systems.

### **Execute-Disable Bit Capability**

This item allows you to enable or disable the No-Execution page protection technology.

### **Intel® HT Technology**

This item allows you to enable or disable Intel Hyper Threading technology.

### **A20M**

This makes legacy OS compatible with some APs.

### **Intel® SpeedStep™ tech**

When set to disabled, the CPU runs at its default speed, when set to enabled, the CPU speed is controlled by the operating system.

### **Intel® TurboMode tech**

Turbo mode allows processor cores to run faster than marked frequency for specific conditions.

### **Intel® C-STATE tech**

This function saves CPU power consumption when in system halt state. When enabled, the CPU speed and voltage will be reduced during system halt state to save power consumption. You may choose to enable or disable it.

### 3.3.2 IDE Configuration

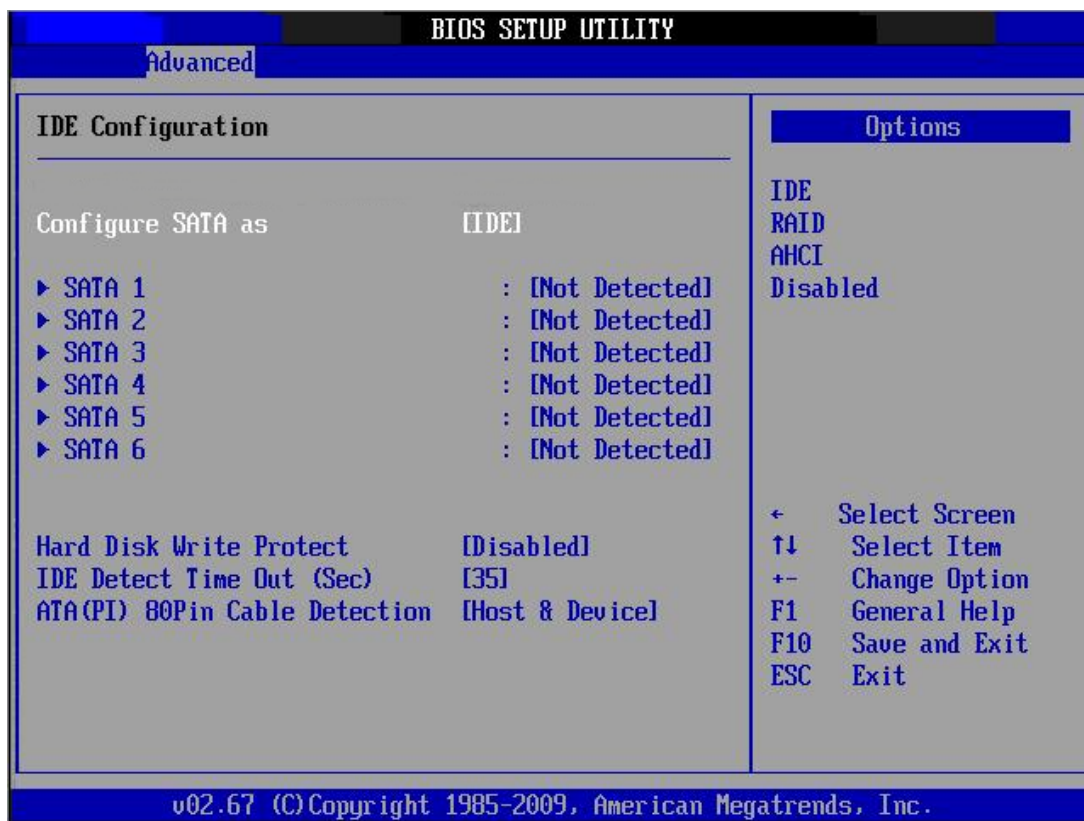

Figure 3.6 IDE Configuration

#### SATA Configuration

This can be configured as IDE, RAID or AHCI.

#### SATA1/SATA2/SATA3/SATA4/SATA5/SATA6

While entering setup, the BIOS automatically detects the presence of SATA devices. This displays the status of SATA device auto-detection.

#### Hard Disk Write Protect

Disable/Enable device write protection. This will be effective only if device is accessed through BIOS.

#### IDE Detect Time Out (Sec)

This item allows you to select the time out value for detecting ATA/ATAPI device(s).

#### ATA(PI) 80 Pin Cable Detection

Select the mechanism for detecting 80Pin ATA(PI) Cable. There are three options, [Host & Device][Host][Device]



### 3.3.3 Floppy Configuration

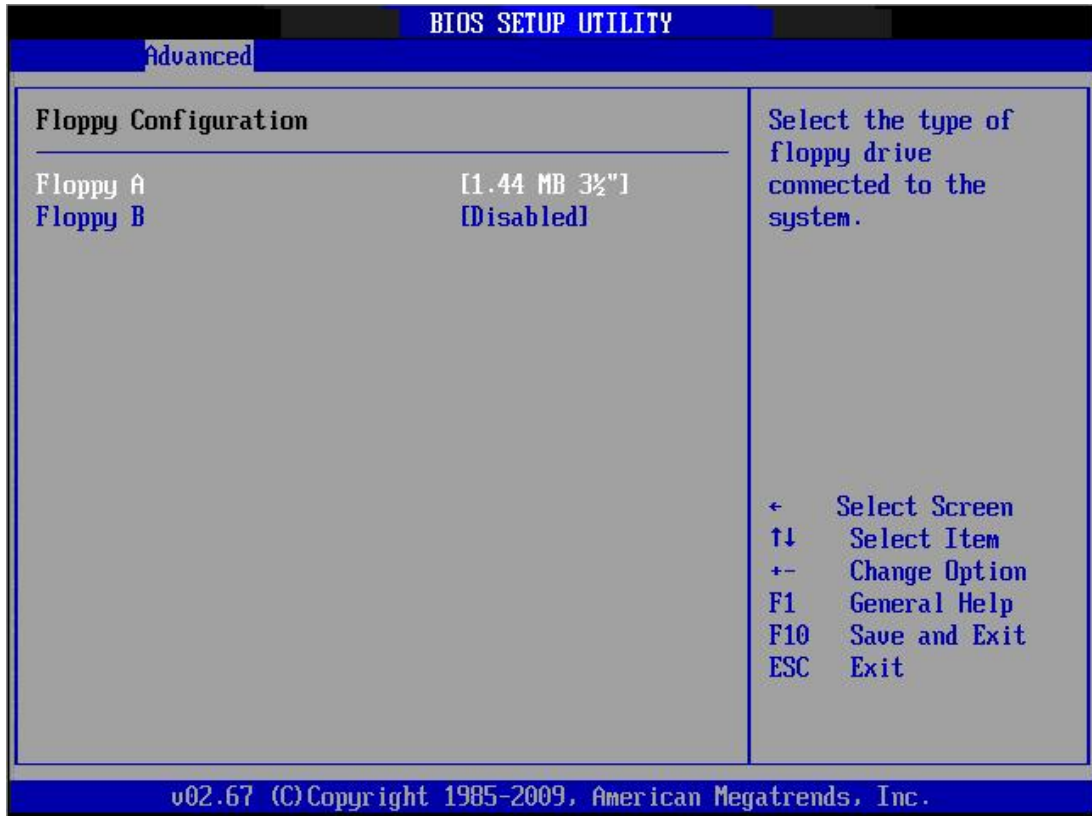

Figure 3.7 Floppy Configuration

#### Floppy A

This item allows users to select the type of floppy drive connected to the system.

#### Floppy B

This item allows users to select the type of floppy drive connected to the system.

### 3.3.4 Super I/O Configuration

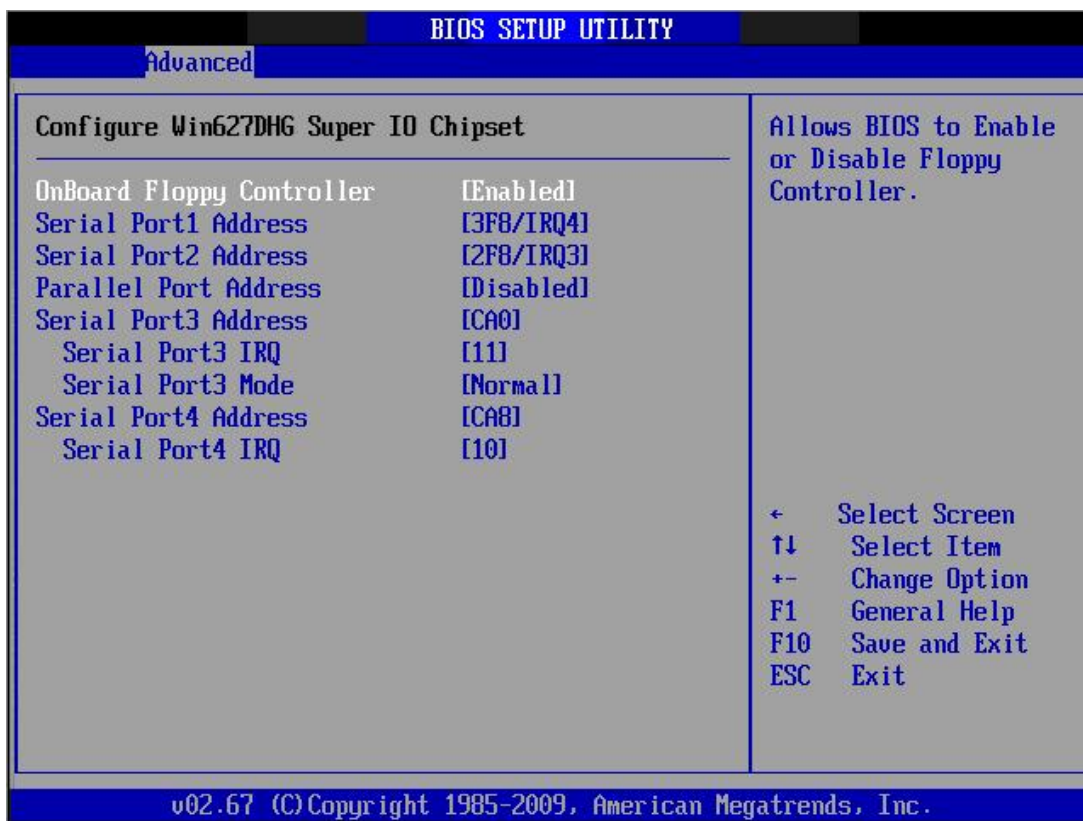

Figure 3.8 Super I/O Configuration

#### OnBoard Floppy Controller

This option allows the BIOS to Enable or Disable the floppy controller.

#### Serial Port1 Address

This option configures serial port 1 base addresses.

#### Serial Port2 Address

This option configures serial port 2 base addresses.

#### Parallel Port Address

This configures parallel port base addresses.

#### Parallel Port Mode (This item is offered when the parallel port address is enabled)

This item allows the user to set parallel port mode, and there are four options, [Bi-Directional] \ [ECP] \ [EPP] \ [ECP&EPP]

#### Serial Port 3 Address

This option configures serial port 3 base address.

#### Serial Port 3 IRQ

This option configures serial port 3 base IRQ.

#### Serial port3 Mode

This option configures serial port 3 mode.

#### Serial Port 4 Address

This option configures serial port 4 base address.

#### Serial Port 4 IRQ

This option configures serial port 4 base IRQ.

### 3.3.5 Hardware Health Configuration

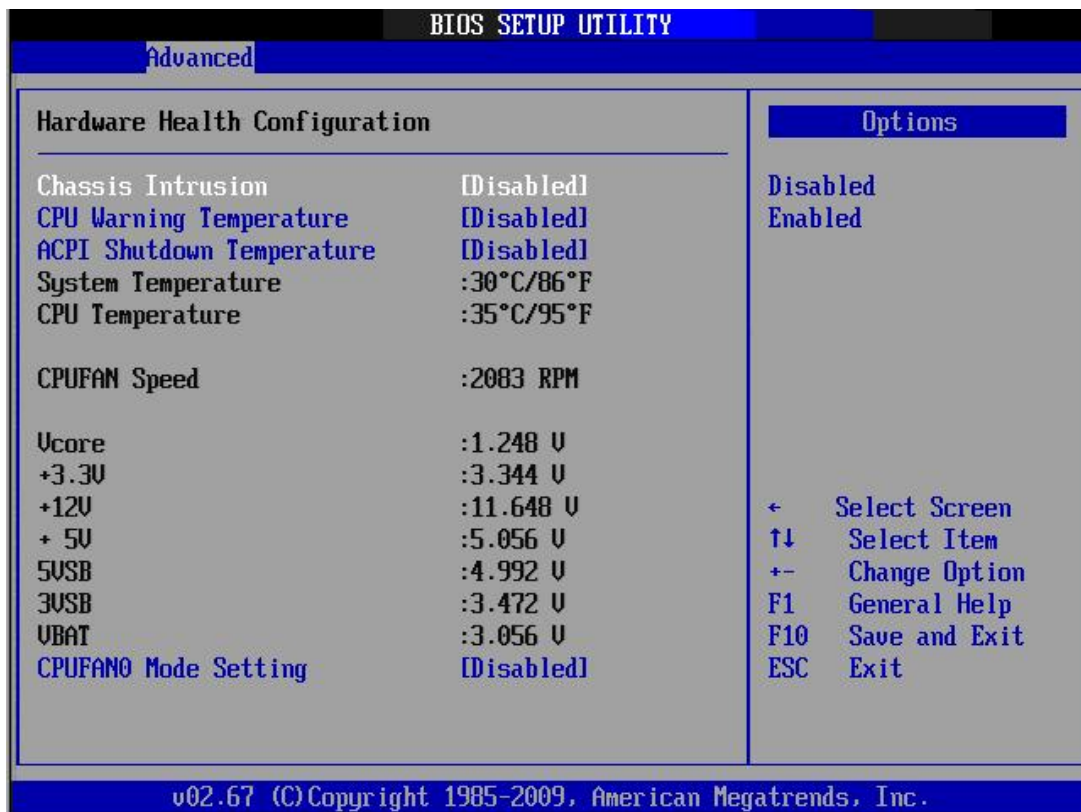

Figure 3.9 Hardware health configuration

#### Chassis Intrusion

Enable/Disable the Chassis Intrusion monitoring function. When the case is opened, the buzzer beeps.

#### CPU Warning Temperature

Use this to set the CPU warning temperature threshold. When the system reaches the warning temperature, the buzzer will beep.

#### ACPI Shutdown Temperature

The system will shut down automatically under OS with ACPI mode, when the CPU temperature is over the selected setting.

#### System Temperature

The onboard hardware monitor automatically detects and displays the system temperatures.

#### CPU Temperature

The onboard hardware monitor automatically detects and displays the CPU temperatures.

#### CPUFAN Speed

Show CPU FAN speed [xxxxRPM].

#### CPUFAN0 Mode Setting

To enable or disable the Smart fan control feature.



## 3.4 ACPI Settings

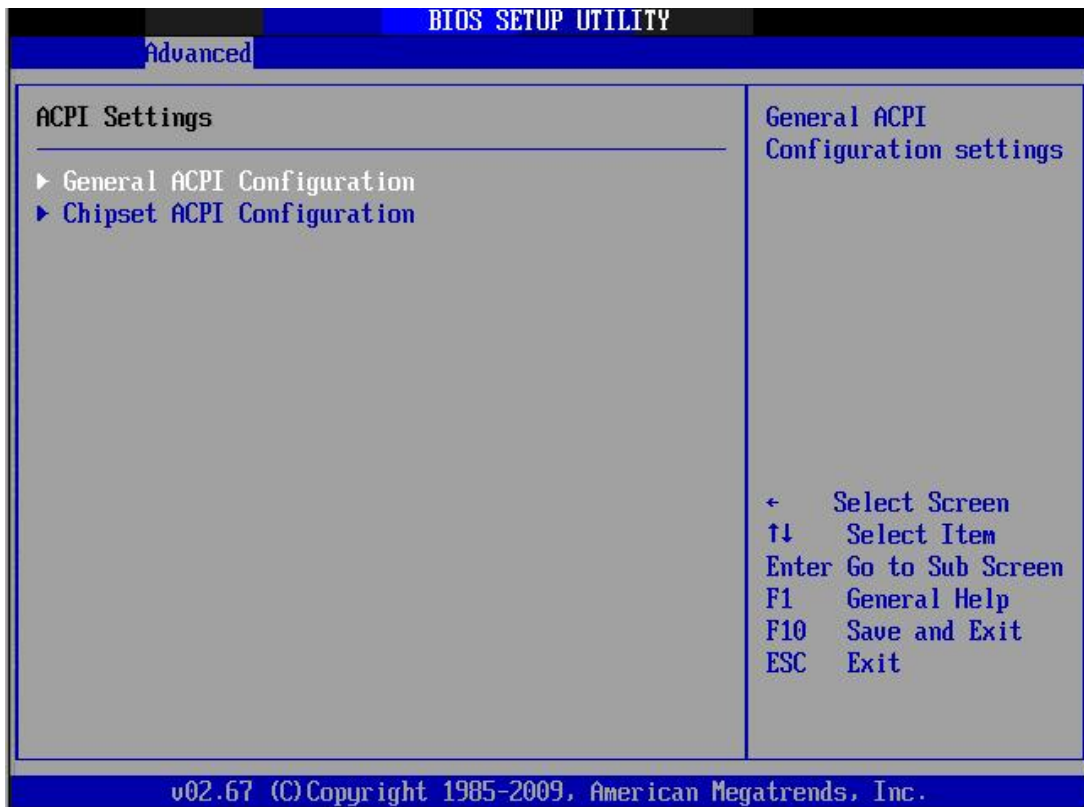

Figure 3.10 ACPI Settings

### 3.4.1 General ACPI Configuration

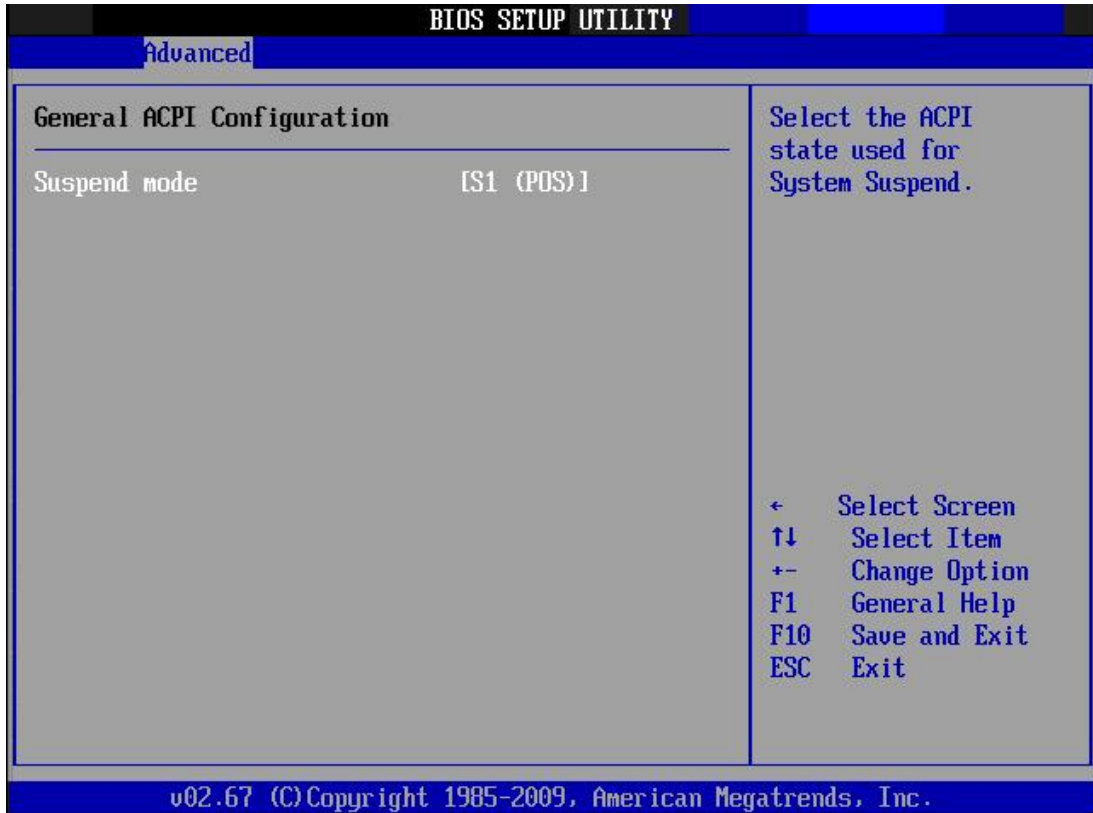

Figure 3.11 General ACPI Configuration

#### Suspend mode

Allows you to select the Advanced Configuration and Power Interface(ACPI) state to be used for system suspend.

- [Auto] The system automatically configures the ACPI suspend mode.
- [S1(POS) only] Sets the ACPI suspend mode to S1/POS (Power On Suspend).
- [S3 only] Sets the ACPI suspend mode to S3/STR (Suspend to RAM)

#### Report Video on S3 Resume (This item would be offered when Suspend mode is set to Auto or S3)

Determines whether to invoke VGA BIOS post on S3/STR resume

### 3.4.2 Chipset ACPI Configuration

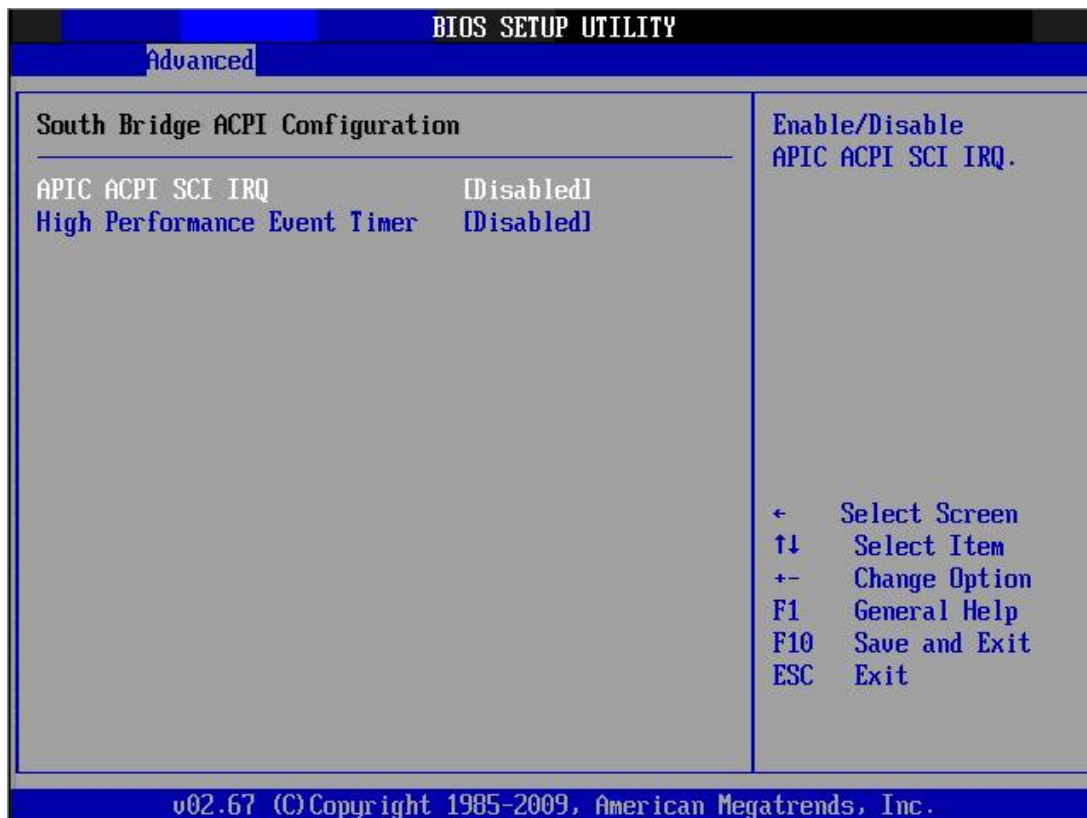

Figure 3.12 Chipset ACPI Configuration

#### APIC ACPI SCI IRQ

Enable/Disable APIC ACPI SCI IRQ.

#### High Performance Event Timer

Enable/Disable High performance event timer.

### 3.4.3 AHCI Configuration

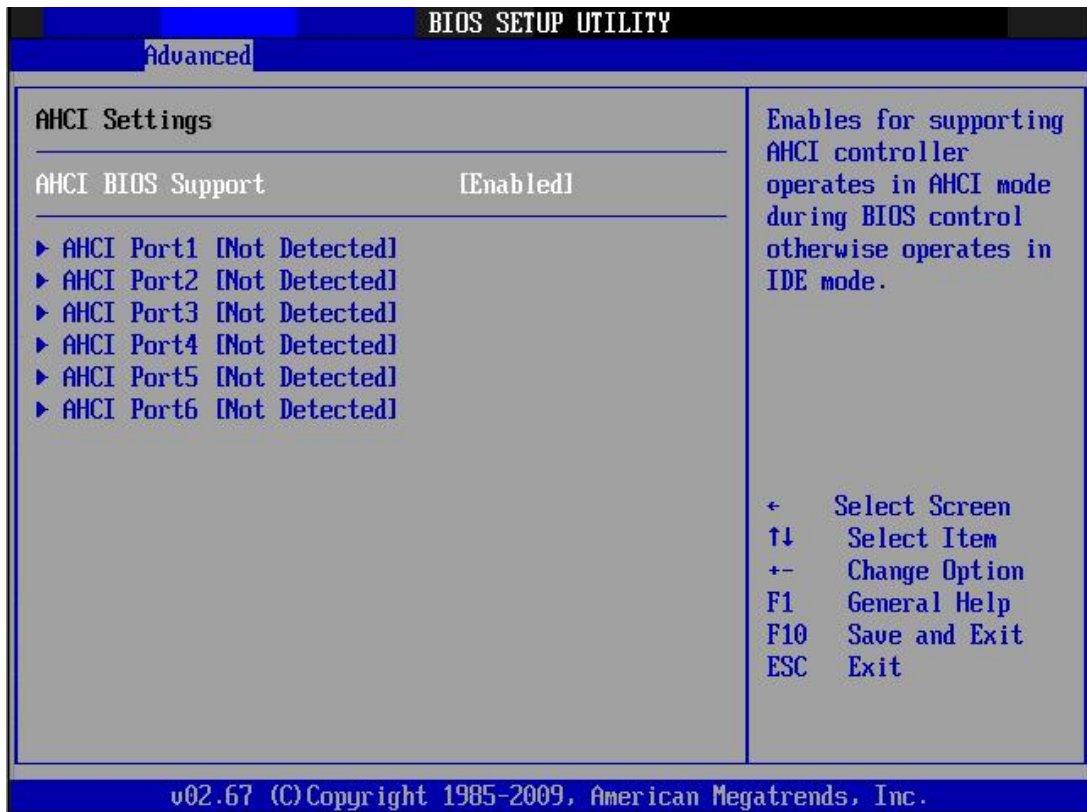

Figure 3.13 AHCI Configuration

#### AHCI Port1-6 [XXXX]

Displays the status of auto-detection of SATA devices.

#### AHCI Port1-6 [Auto]

[Auto] Allows automatic selection of the device type connected to the system.

[Not Detected] Selects this option if no SATA devices are installed.

### 3.4.4 ASF Configuration

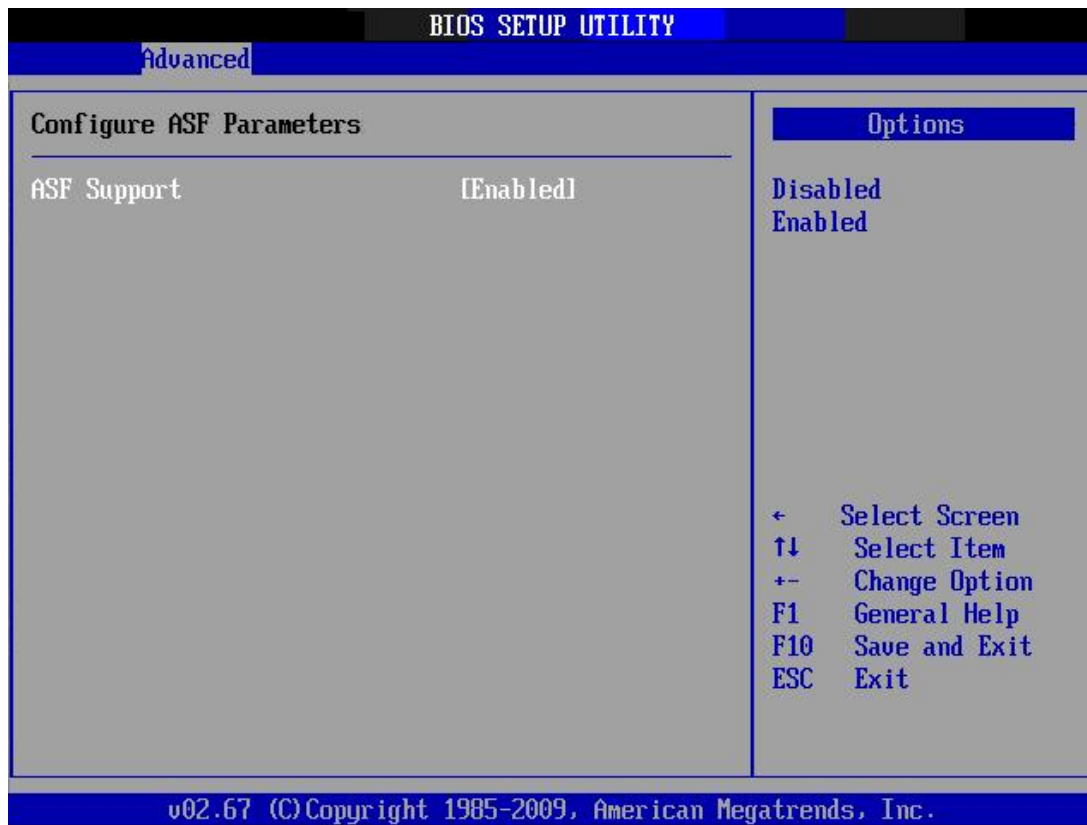

Figure 3.14 ASF Configuration

#### ASF Support

ASF (Alert Standard Format) provides standards-based alerting and remote control. Both the alerting and remote control capabilities of ASF are hardware-based and local to the networking solution on managed systems. This allows these solutions CPU and OS independence, providing a persistent connection with the management console.

### 3.4.5 MPS Configuration

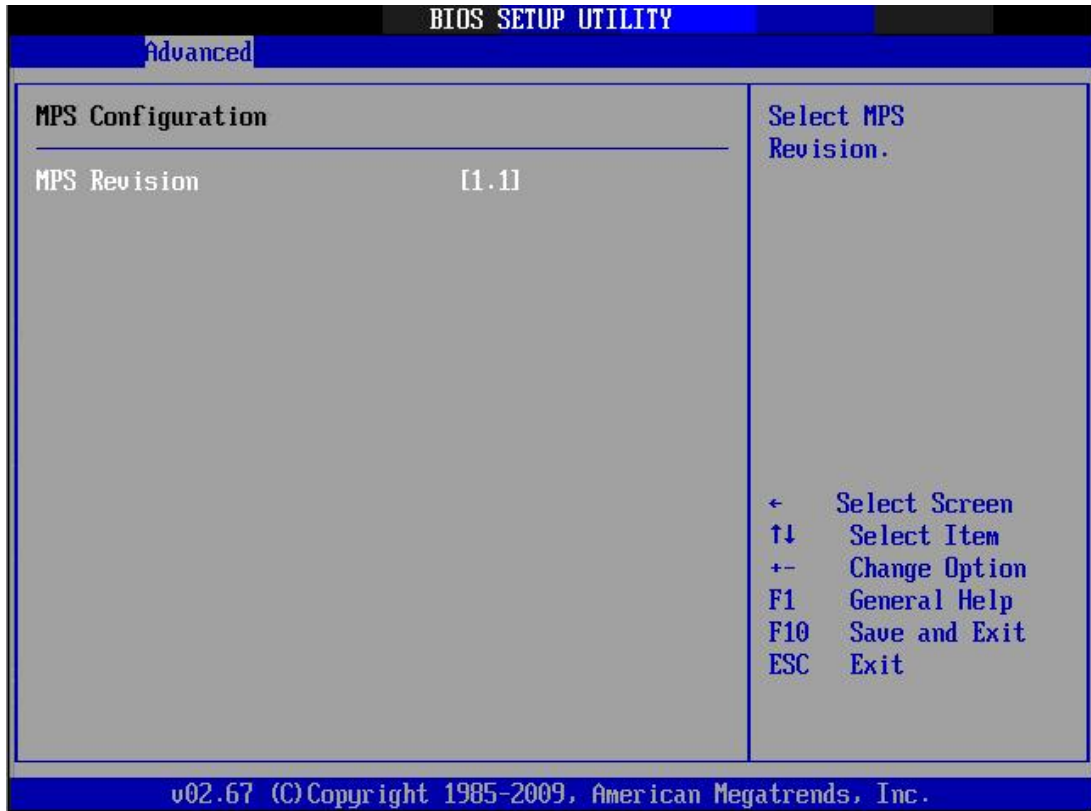
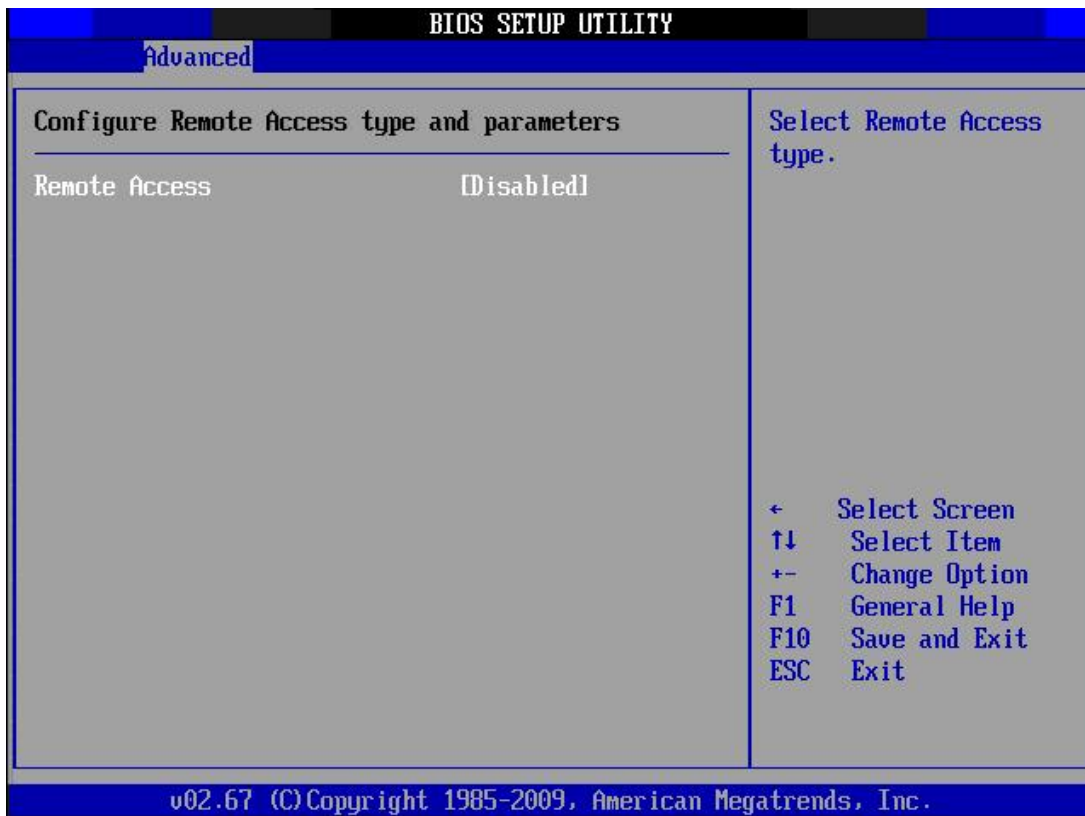

Figure 3.15 MPS Configuration

#### MPS Revision

This feature is only applicable to multiprocessor motherboards as it specifies the version of the Multi-Processor Specification (MPS) that the motherboard will use. The MPS is a specification by which PC manufacturers design and build Intel architecture systems with two or more processors.

### 3.4.6 Remote Access Configuration



**Figure 3.16 Remote Access Configuration**

You can disable or enable the BIOS remote access feature here. This function is used to redirect the console from the serial port. The Optimal and Fail-Safe default setting is Disabled.

**Note!** *If you want to use SOL, which is provided by Intel AMT, you have to enable the Remote access feature.*



### 3.4.7 Trusted Computing (Optional)

To enable/disable TPM/TCG (TPM1.1/1.2) setup in BIOS. TCG (Trusted Computing Group) standards today are based on a special purpose security chip, placed in a PC, called a Trusted Platform Module (TPM). TPM is a secure key generator and key cache management component, it enables protected storage of encryption keys and authentication credentials for enhanced security capabilities.

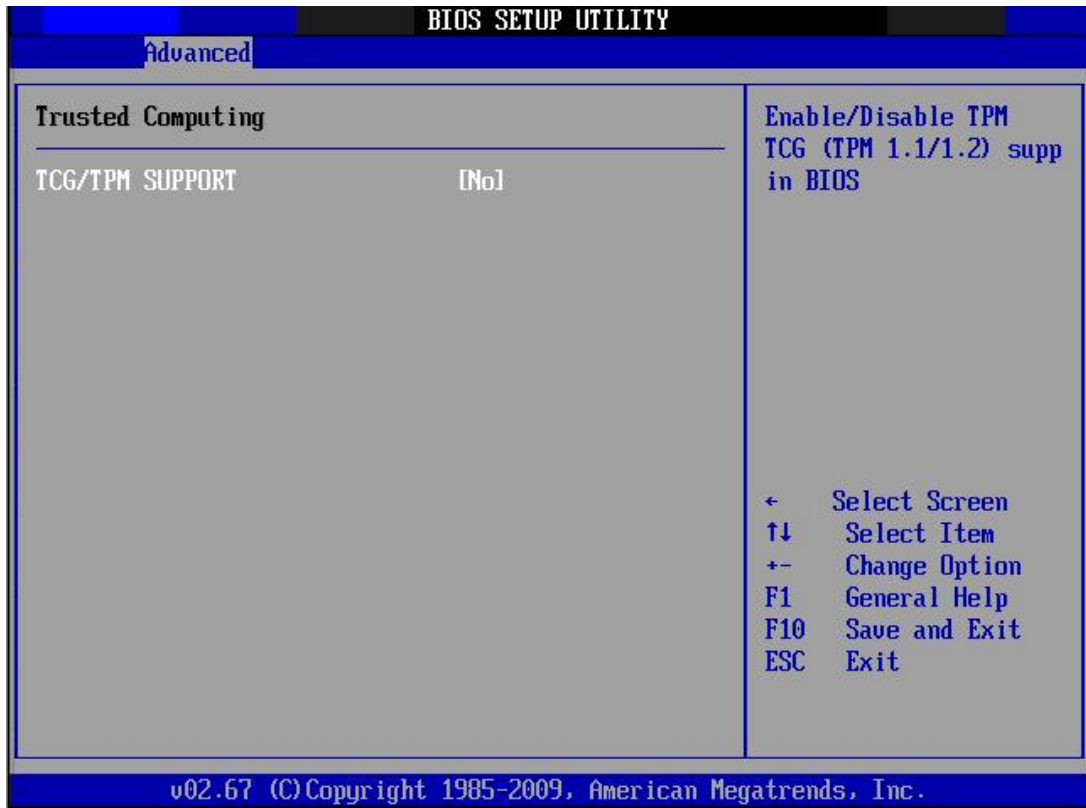
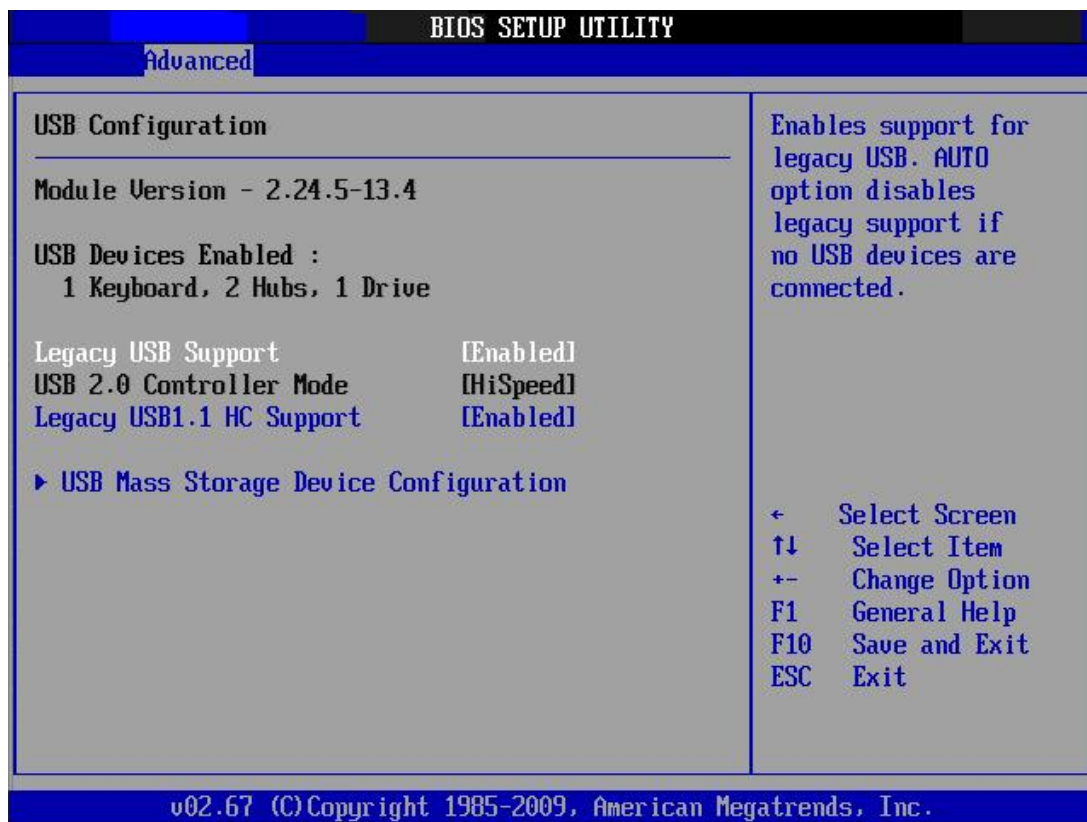

Figure 3.17 Trusted Computing Configuration



### 3.4.8 USB Configuration



**Figure 3.18 USB Configuration**

#### **Legacy USB Support (This item is offered in QG2 SKU)**

Enables support for legacy USB. Auto option disables legacy support if no USB devices are connected.

#### **USB 2.0 Controller Mode**

This item allows you to select Hi-Speed (480 Mbps) or Full-Speed (12 Mbps).

#### **Legacy USB1.1 HC Support (This item is offered in QG2 SKU)**

Allows the system to detect the presence of USB devices at startup. If detected, the USB controller legacy mode is enabled. If no USB device is detected, the legacy USB support is disabled.

## 3.5 Advanced PCI/PnP Settings

Select the PCI/PnP tab from the AIMB-780 setup screen to enter the Plug and Play BIOS Setup screen. You can display a Plug and Play BIOS Setup option by highlighting it using the <Arrow> keys. All Plug and Play BIOS Setup options are described in this section. The Plug and Play BIOS Setup screen is shown below.

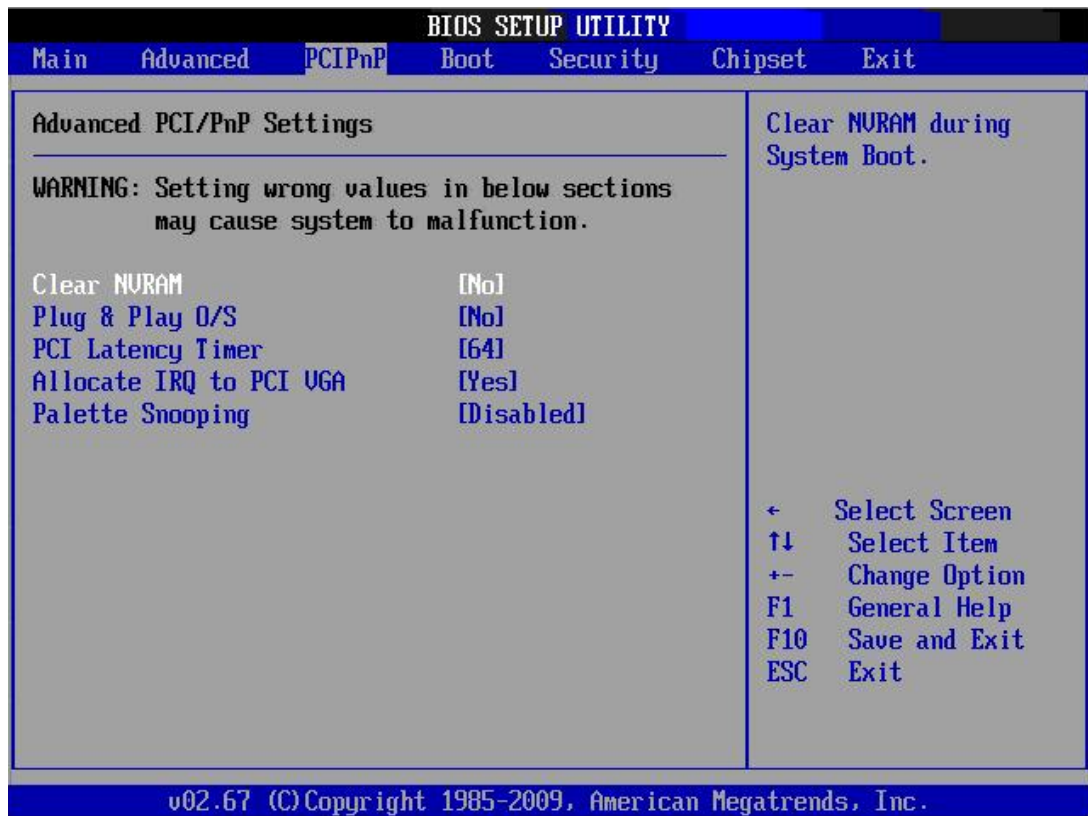

Figure 3.19 PCI/PNP Setup (top)

### Clear NVRAM

Set this value to force the BIOS to clear the Non-Volatile Random Access Memory (NVRAM). The Optimal and Fail-Safe default setting is No.

### Plug & Play O/S

When set to No, BIOS configures all the devices in the system. When set to Yes and if you install a Plug and Play operating system, the operating system configures the Plug and Play devices not required for bootup.

### PCI Latency Timer

Value in units of PCI clocks for PCI device latency timer register.

### Allocate IRQ to PCI VGA

When set to Yes, will assign IRQ to PCI VGA card if card requests IRQ. When set to No will not assign IRQ to PCI VGA card even if the card requests an IRQ.

### Palette Snooping

This item is designed to solve problems caused by some non-standard VGA cards.

### 3.6 Boot Settings

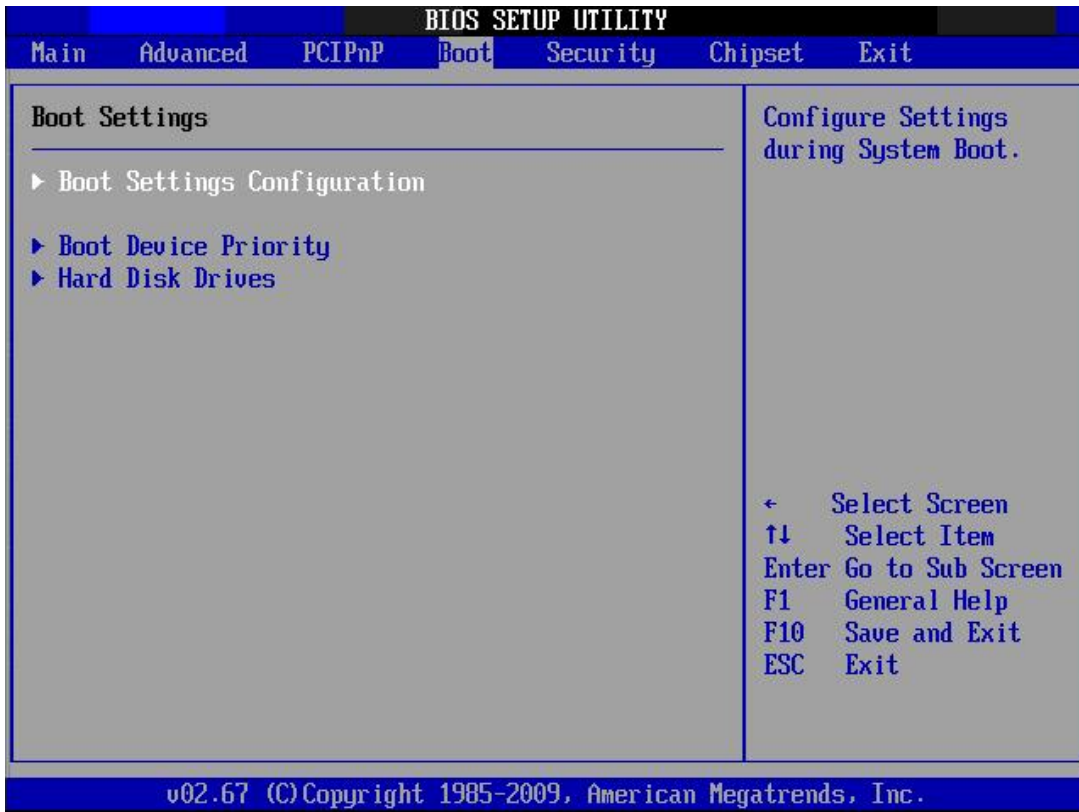

Figure 3.20 Boot Setup Utility

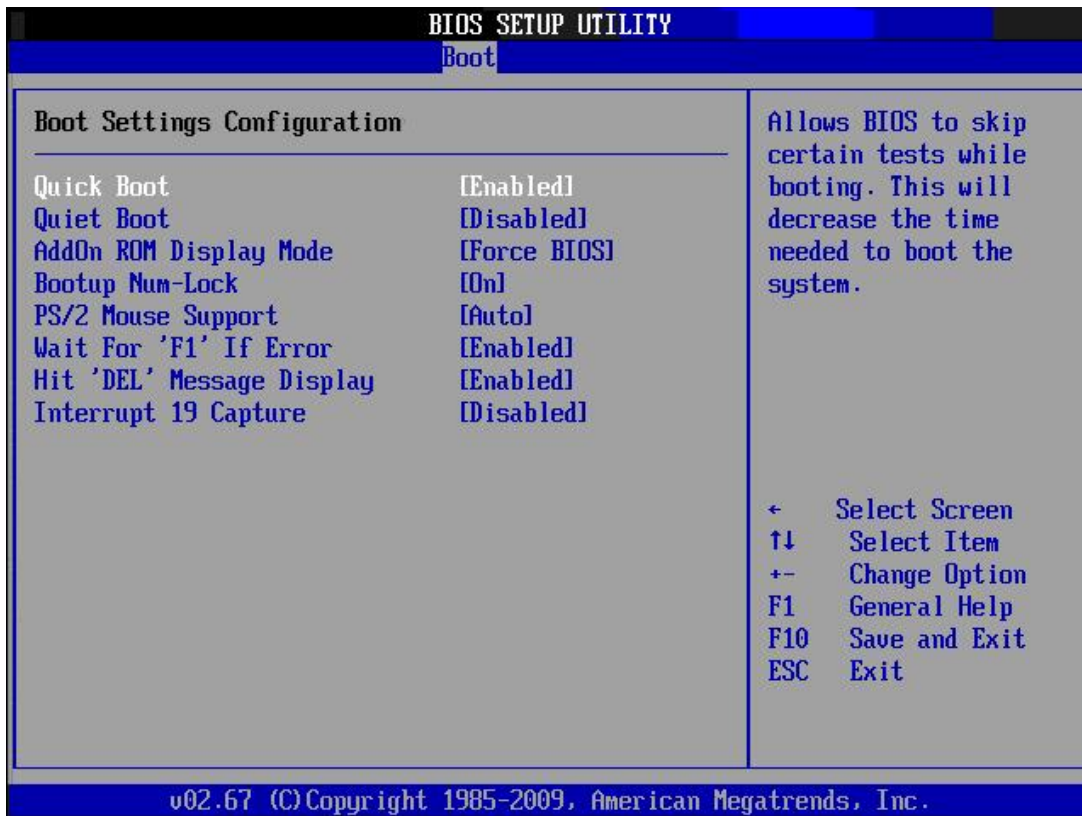

Figure 3.21 Boot Setting Configuration

### Quick Boot

This item allows BIOS to skip certain tests while booting. This will decrease the time needed to boot the system.

### Quiet Boot

If this option is set to Disabled, the BIOS displays normal POST messages. If Enabled, an OEM Logo is shown instead of POST messages.

### AddOn ROM Display Mode

Set display mode for option ROM.

### Startup Num-Lock

Select the Power-on state for Numlock.

### PS/2 Mouse Support

Select support for PS/2 Mouse.

### Wait For 'F1' If Error

Wait for the F1 key to be pressed if an error occurs.

### Hit 'DEL' Message Display

Displays "Press DEL to run Setup" in POST.

### Interrupt 19 Capture

Some add-on cards' option ROMs need Interrupt 19, this is to enable or disable supporting this kind of add-on cards.

## 3.7 Security Setting

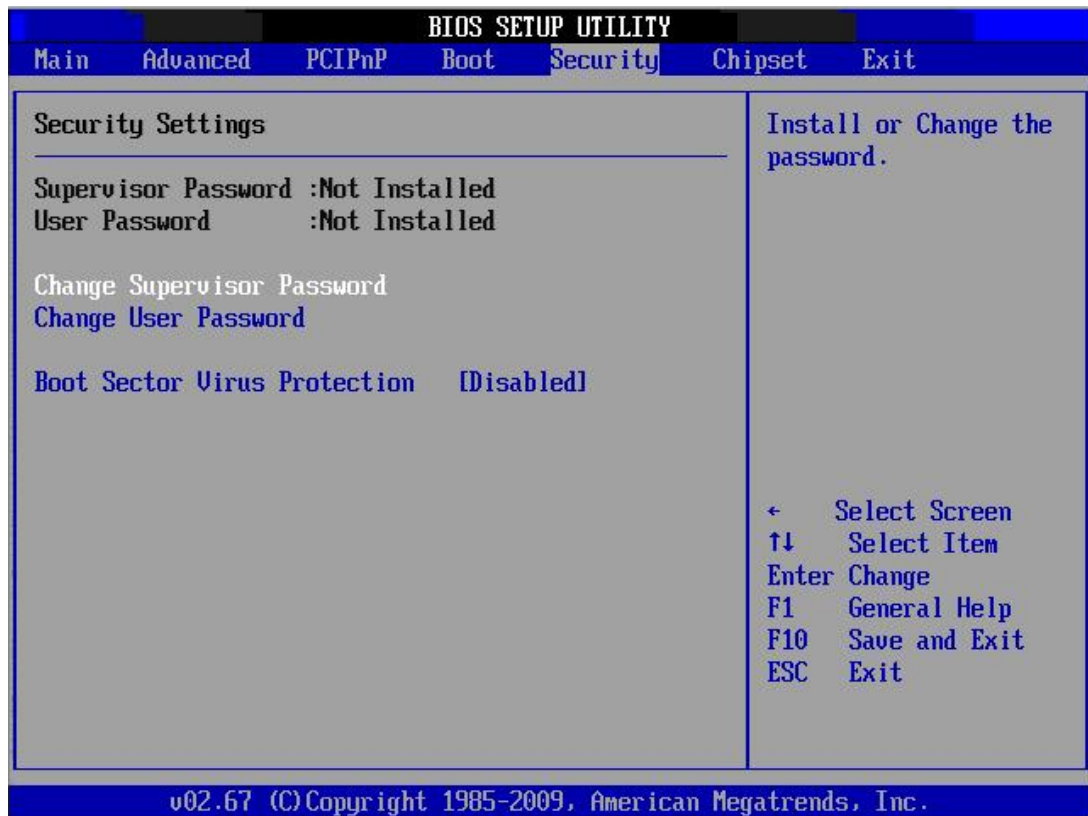

Figure 3.22 Password Configuration

Select Security Setup from the AIMB-780 Setup main BIOS setup menu. All Security Setup options, such as password protection and virus protection are described in this section. To access the sub menu for the following items, select the item and press <Enter>:

#### Change Supervisor / User Password

Provides for either installing or changing the password.

#### Boot sector Virus protection

The boot sector virus protection will warn if any program tries to write to the boot sector.

## 3.8 Advanced Chipset Settings



Figure 3.23 Advanced Chipset Settings



## 3.8.1 North Bridge Chipset Configuration

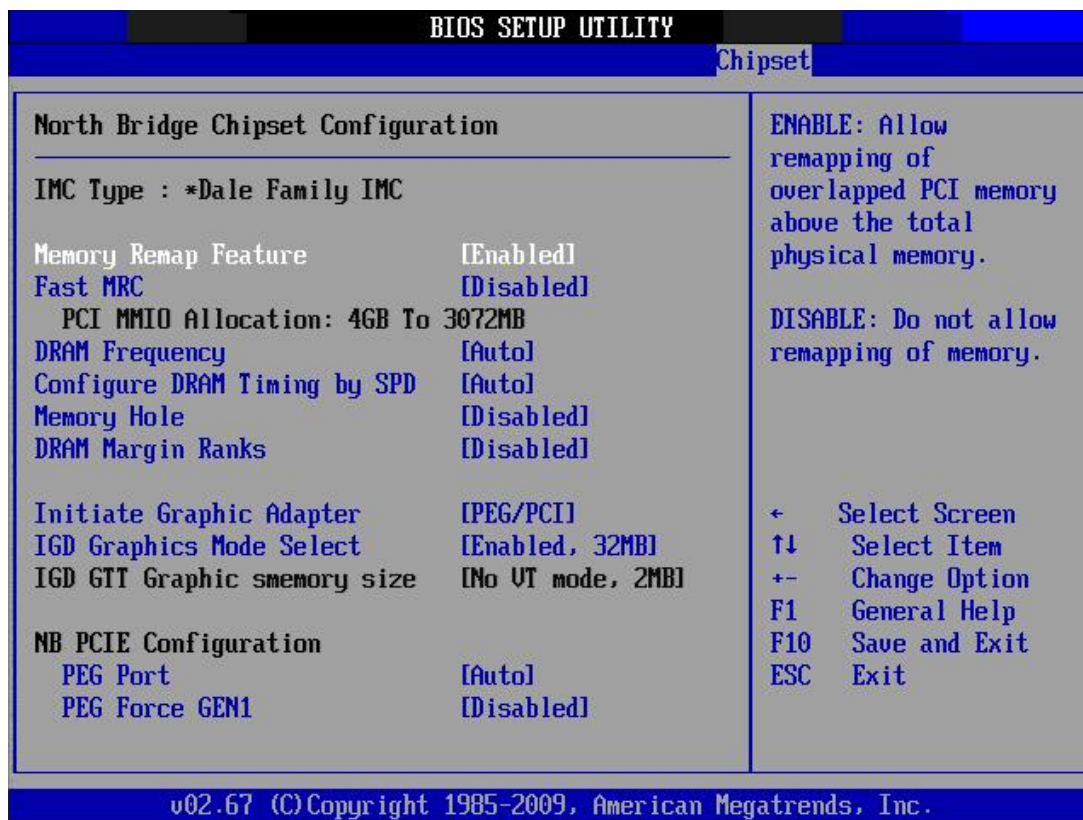

Figure 3.24 North Bridge Configuration

### Memory Remap Feature

Enabling this feature allows the system to use memory capacity larger than 4GB, disabling this limits system memory capacity no more than 4GB.

### Fast MRC (This item would be offered in QG2 SKU)

Enabling this feature allows MRC directly restores memory data from NVRAM without hardware training while cold booting. Disabling this will make memory detection and hardware training necessary while cold booting.

### DRAM Frequency

This setting allows the user to select DRAM frequency.

### Configure DRAM Timing by SPD

When enabled, DRAM will operate with a frequency set by SPD, disabling this will allow the user to manually set DRAM frequency.

### Memory Hole

This setting allows the user to reserve the 1MB of memory required by some legacy add-on cards.

### DRAM Margin Ranks

This allows the user to enable or disable the DRAM Margin Ranks function.

### Initiate Graphic Adapter

This setting allows the user to select which graphics controller to be the primary graphic device when booting up.

### IGD Graphics Mode Select

Allows you to decide whether to use the integrated GPU and select the amount of memory used by the integrated GPU.

**PEG Port**

This is for the user to choose manually enabling or disabling PCIe graphic port or leave it to automatically detect presence of a add-on PEG graphic card.

**PEG Force GEN1**

This setting allows the user to manually downgrade PEG port to Gen 1.

**Video Function Configuration**

This item is allows the user to set Video memory. There are three options, [128MB]/[256MB]/[Maximum DVMT]

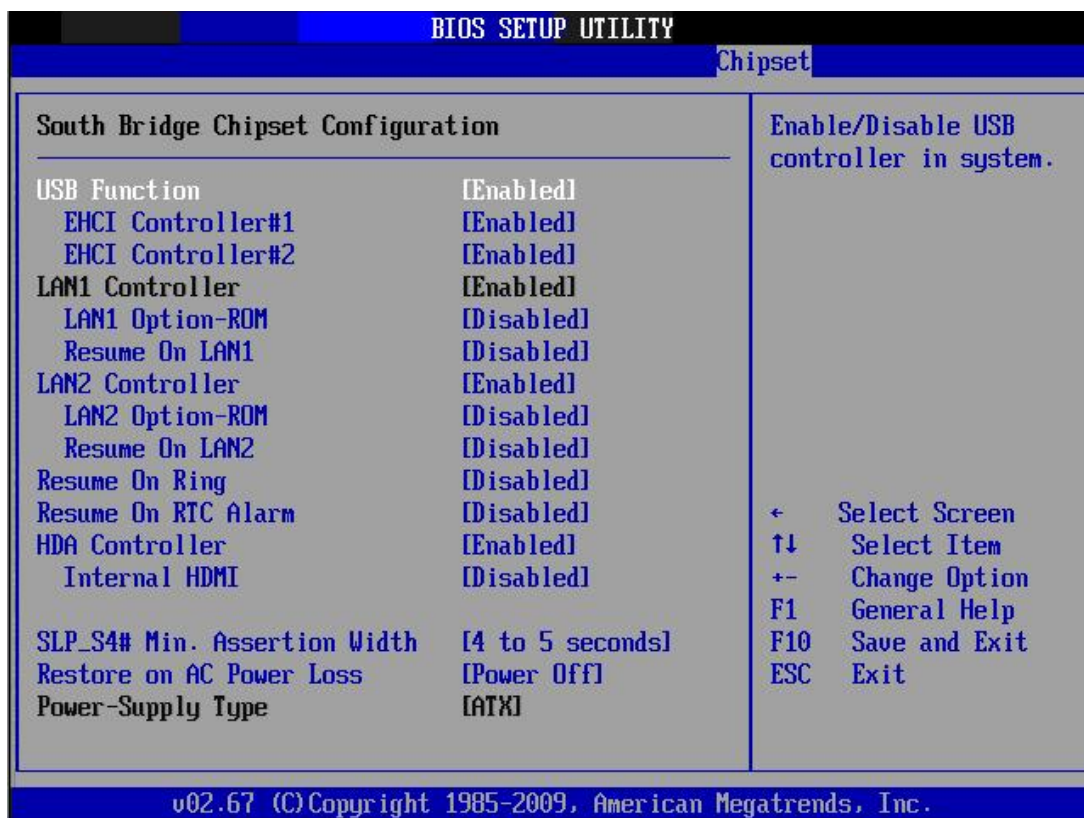
**3.8.2 South Bridge Chipset Configuration**

**Figure 3.25 South Bridge Chipset Configuration**

**USB Functions**

Select: Enable/Disabled USB controller in system.

**EHCI Controller#1**

Enable or disable Integrated USB 2.0 RMH#1

**EHCI Controller#2**

Enable or disable Integrated USB 2.0 RMH#2

**LAN1 Controller**

Enables or disables the LAN1 controller.

**LAN1 Option-ROM**

Enables or disables LAN1 option-ROM.

**Resume On LAN1**

Enables or disables LAN1 resuming.

### LAN2 Controller

Enables or disables the LAN2 controller.

### LAN2 Option-ROM

Enables or disables LAN2 option-ROM.

### Resume On LAN2

Enables or disables LAN2 resuming.

### Resume on Ring

Enabling this will allow the system to be woken up by modem ringing.

### Resume on RTC Alarm

Enabling this will allow the system to be woken up by RTC alarm.

### HDA Controller

Enables or disables the High Definition audio controller.

### Internal HDMI

Enables or disables the HDMI controller.

### SLP\_S4# Min. Assertion Width

This item allows you to set a delay of a set number of seconds.

### Restore on AC Loss

This allow the user to define how the system responds to power restore after AC power loss.

### Power Type

This allows the user to choose power type.

## 3.8.3 Intel AMT Configuration

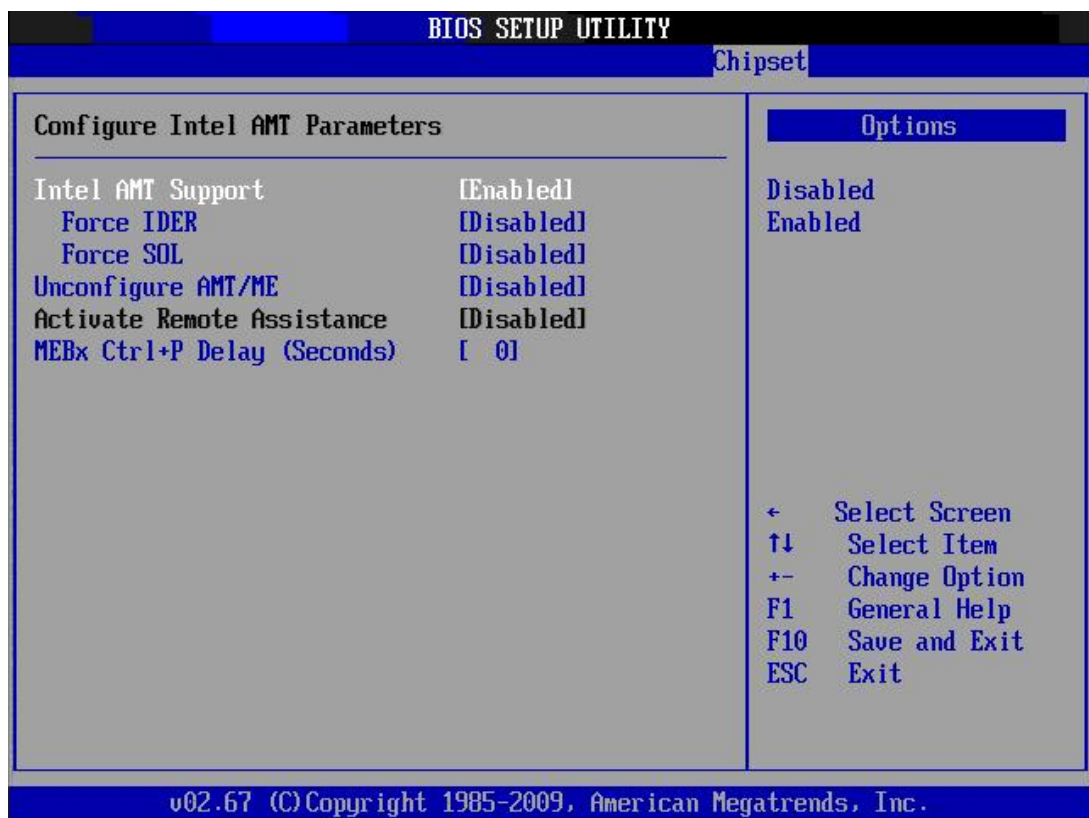

Figure 3.26 Intel AMT Configuration



**Intel AMT Support**

Enables or disables Intel AMT function.

**Force IDER**

Enables or disables IDE redirection under Intel AMT support.

**Force SOL**

Enables or disables SOL under Intel AMT support.

**Note!** *If you enable SOL here, the remote access has been set as enable which is described in section 3.7.*

**Unconfigure AMT/ME**

This item allows the user to clear ME settings.

**Activate Remote Assistance**

This item allows the user to enable or disable remote assistance features.

**MEBx Ctrl+P Delay (Seconds)**

This item allows the user to set delay times to show "Ctrl + P" for entering ME setting configuration.

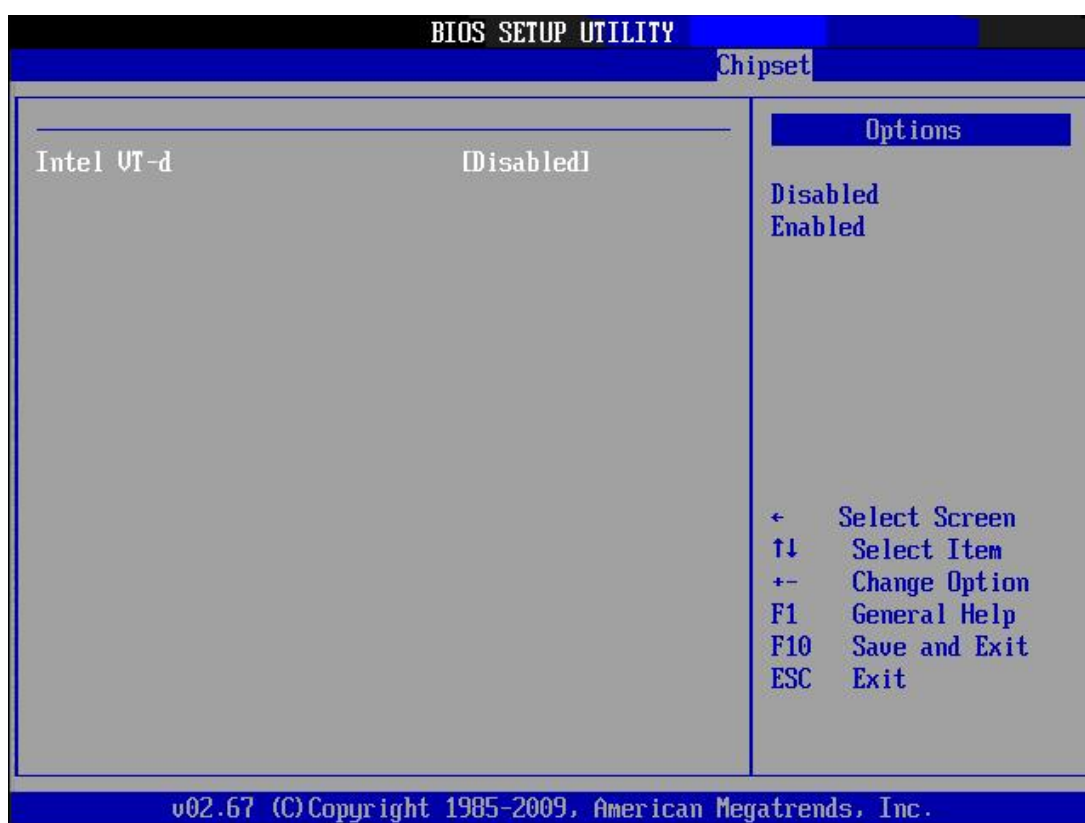
**3.8.4 Intel VT-d Configuration**

**Figure 3.27 Intel VT-d Configuration**

**Intel VT-d Configuration**

To support Intel chipset virtualization technology for directed I/O.

### 3.8.5 ME Subsystem Configuration

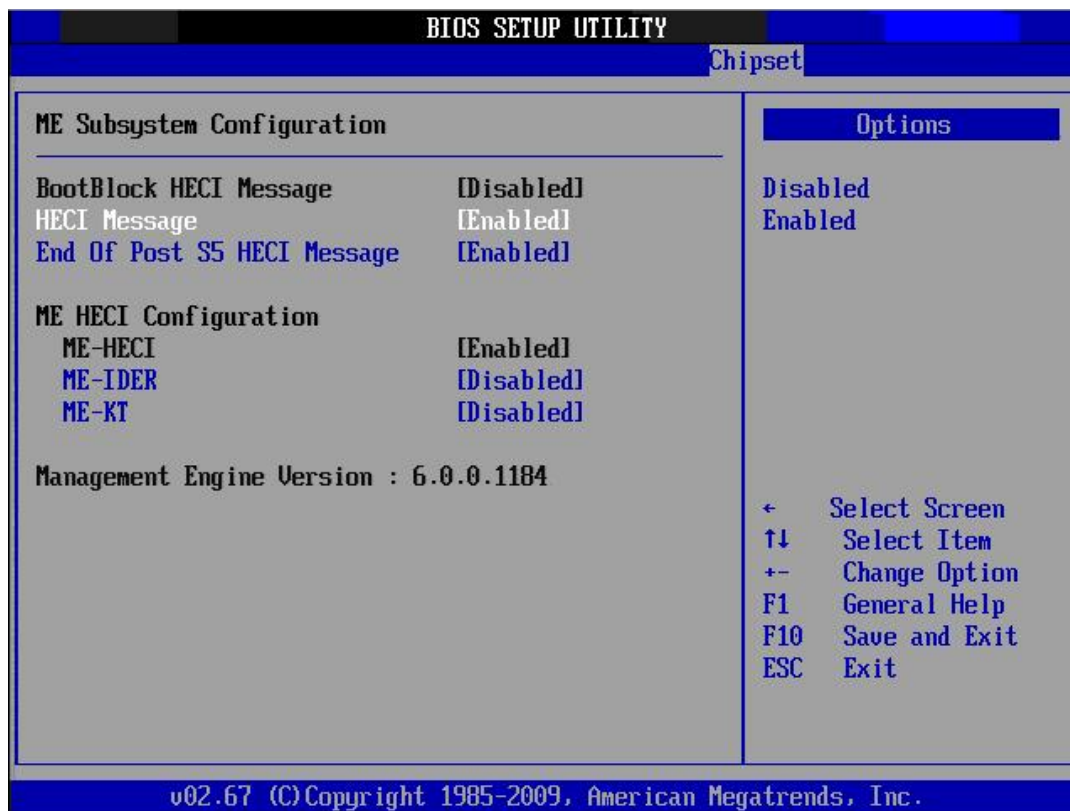

Figure 3.28 ME Subsystem Configuration

#### Boot Block HECI Message

This allows the user to enable or disable Boot Block HECI messaging between system BIOS code and ME code.

#### HECI Message

This allows the user to enable or disable HECI messaging between system BIOS code and ME code.

#### End of POST S5 HECI Message

Enabling this will let system BIOS code to inform ME code ending of POST S5 via HECI messaging.

#### ME HECI Configuration

##### ME-HECI

This allows the user to enable or disable HECI function of ME.

##### ME-IDER

This allows the user to enable or disable IDE redirection function of ME.

##### ME-KT

This allows the user to enable or disable KT function of ME.

### 3.8.6 VE Subsystem Configuration



**Figure 3.29 VE Subsystem Configuration**

#### Intel VE Subsystem Configuration

VE refers to Intel Virtualization Engine. Access to the PBA area is permitted via the VE by using the VE Command Interface (VECI), or via the Intel ME by using the Intel AT-d Host Command Interface (DHCI); which uses HECI. The VE can ensure that access requests outside the PBA ranges are prevented given that PBA code executes on the host processor.

## 3.9 Exit Option

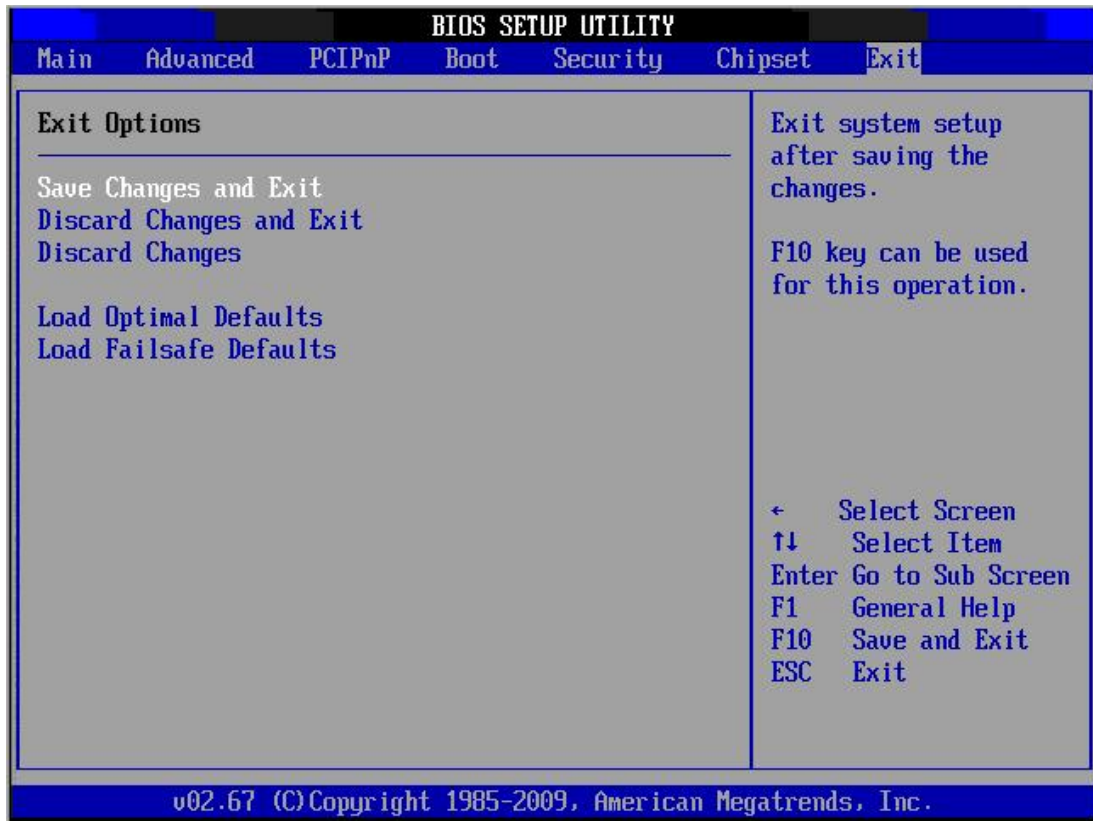

Figure 3.30 Exit Option

### Save Changes and Exit

When you have completed system configuration, select this option to save your changes, exit BIOS setup and reboot the computer so the new system configuration parameters can take effect.

1. Select Save Changes and Exit from the Exit menu and press <Enter>. The following message appears:

Save Configuration Changes and Exit Now?  
[Ok] [Cancel]

2. Select Ok or Cancel.

### Discard Changes and Exit

1. Select Exit Discarding Changes from the Exit menu and press <Enter>. The following message appears:

Discard Changes and Exit Setup Now?  
[Ok] [Cancel]

2. Select Ok to discard changes and exit.

### Discard Changes

Select Discard Changes from the Exit menu and press <Enter>.

### Load Optimal Defaults

The AIMB-780 automatically configures all setup items to optimal settings when you select this option. Optimal Defaults are designed for maximum system performance, but may not work best for all computer applications. In particular, do not use the Optimal Defaults if your computer is experiencing system configuration problems. Select Load Optimal Defaults from the Exit menu and press <Enter>.

**Load Failsafe Defaults**

The AIMB-780 automatically configures all setup options to failsafe settings when you select this option. Failsafe Defaults are designed for maximum system stability, but not maximum performance. Select Failsafe Defaults if your computer is experiencing system configuration problems.

1. Select Save Changes and Exit from the Exit menu and press <Enter>. The following message appears:  
Save Configuration Changes and Exit Now?  
[Ok] [Cancel]
2. Select OK to load Failsafe defaults.



# Chapter 4

Chipset Software  
Installation Utility

## 4.1 Before you begin

To facilitate the installation of the enhanced display drivers and utility software, read the instructions in this chapter carefully. The drivers for the AIMB-780 are located on the software installation CD.

**Note!** *The files on the software installation CD are compressed. Do not attempt to install the drivers by copying the files manually. You must use the supplied SETUP program to install the drivers.*



Before you begin, it is important to note that most display drivers need to have the relevant software application already installed in the system prior to installing the enhanced display drivers. In addition, many of the installation procedures assume that you are familiar with both the relevant software applications and operating system commands. Review the relevant operating system commands and the pertinent sections of your application software's user manual before performing the installation.

## 4.2 Introduction

The Intel Chipset Software Installation (CSI) utility installs the Windows INF files that outline to the operating system how the chipset components will be configured. This is needed for the proper functioning of the following features:

- Core PCI PnP services
- Serial ATA interface support
- USB 1.1/2.0 support (USB 2.0 driver needs to be installed separately for Windows 98)
- Identification of Intel chipset components in the Device Manager

**Note!** *The chipset driver is used for the following versions of Windows, and it has to be installed before installing all the other drivers:*



- *Windows 7 (32-bit)*
- *Windows 7 (64-bit)*
- *Windows XP professional edition (32-bit)*
- *Windows XP professional edition (64-bit)*



## 4.3 Windows XP / Windows 7 Driver Setup

1. Insert the driver CD into your system's CD-ROM drive. You can see the driver folders items. Move the mouse cursor over the folder "CSI". In CSI folder, you can click "setup.exe" to complete the implement of the driver

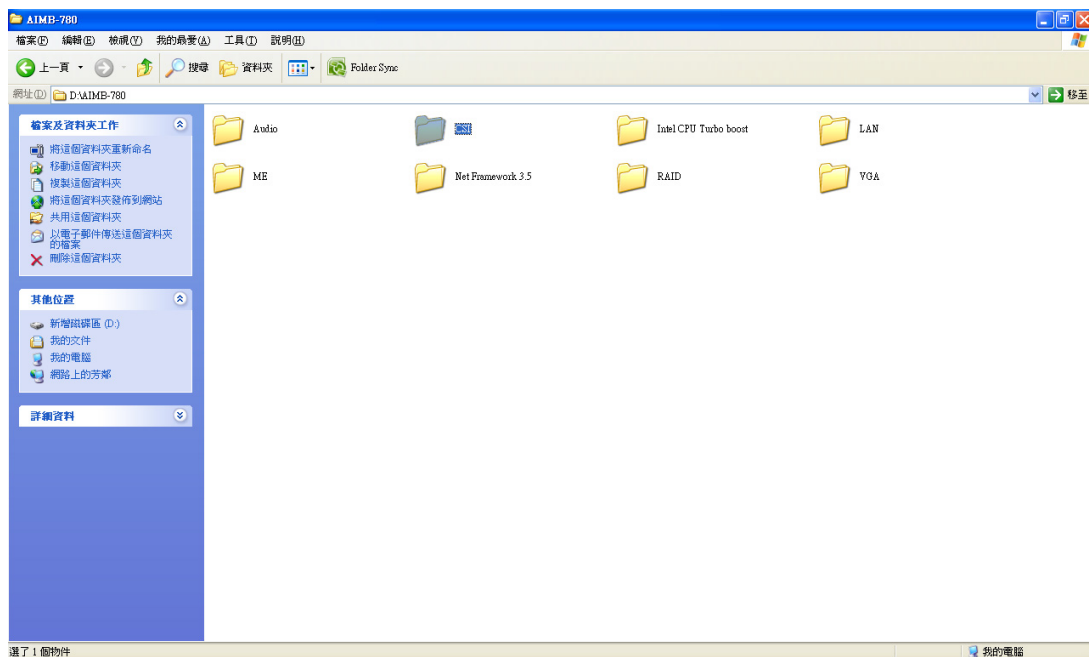

2. Click setup to execute program.

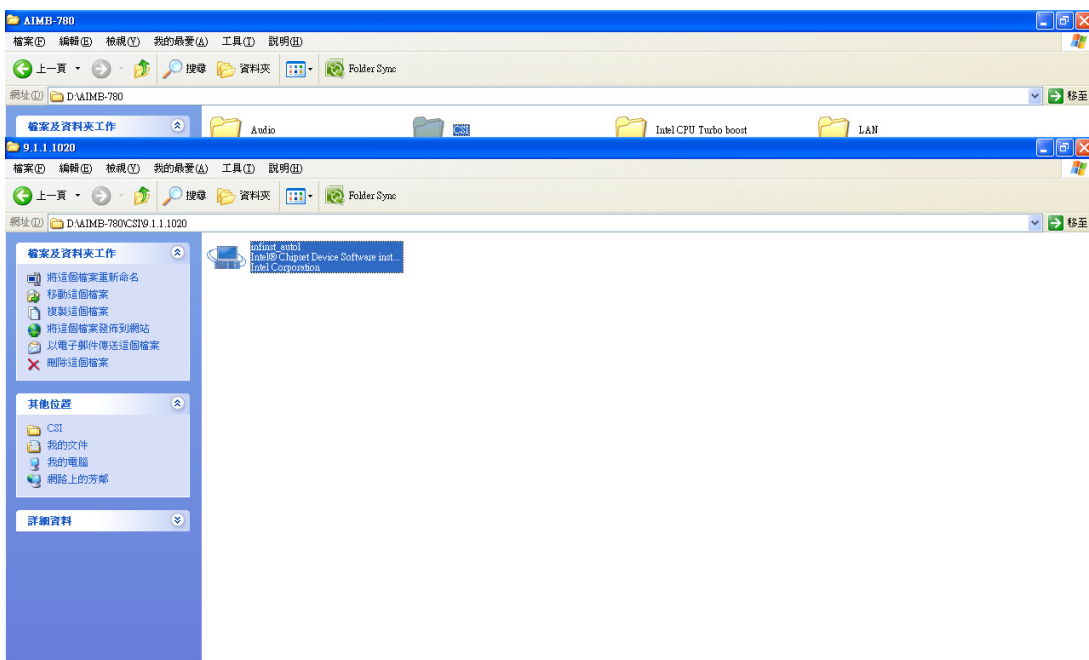



# Chapter 5

## VGA Setup

## 5.1 Introduction

The Intel Core i5-6xx, Core i3-5xx and Pentium CPUs with dual core processors are embedded with integrated graphics controller. You need to install the VGA driver to enable this function, which includes the following features:

- Optimized integrated graphic solution: With Intel Graphics Flexible Display Interface, it supports versatile display options and 32-bit 3D graphics engine. Dual independent display, enhanced display modes for widescreen flat panels for extend, twin, and clone dual display mode, and optimized 3D support deliver an intensive and realistic visual experience. Again, only Core i5-6xx, Core i3-5xx and Pentium CPUs with dual core are embedded with integrated graphics, Core i7, Core i5- 7xx with quad core are not.

## 5.2 Windows XP/Windows 7 Driver Setup

**Note!** Before installing this driver, make sure the INF driver has been installed in your system. See Chapter 4 for information on installing the INF driver.



Insert the driver CD into your system's CD-ROM drive. You can see the driver folders items. Navigate to the "VGA" folder and click "setup.exe" to complete the installation of the drivers for Windows 7, XP.

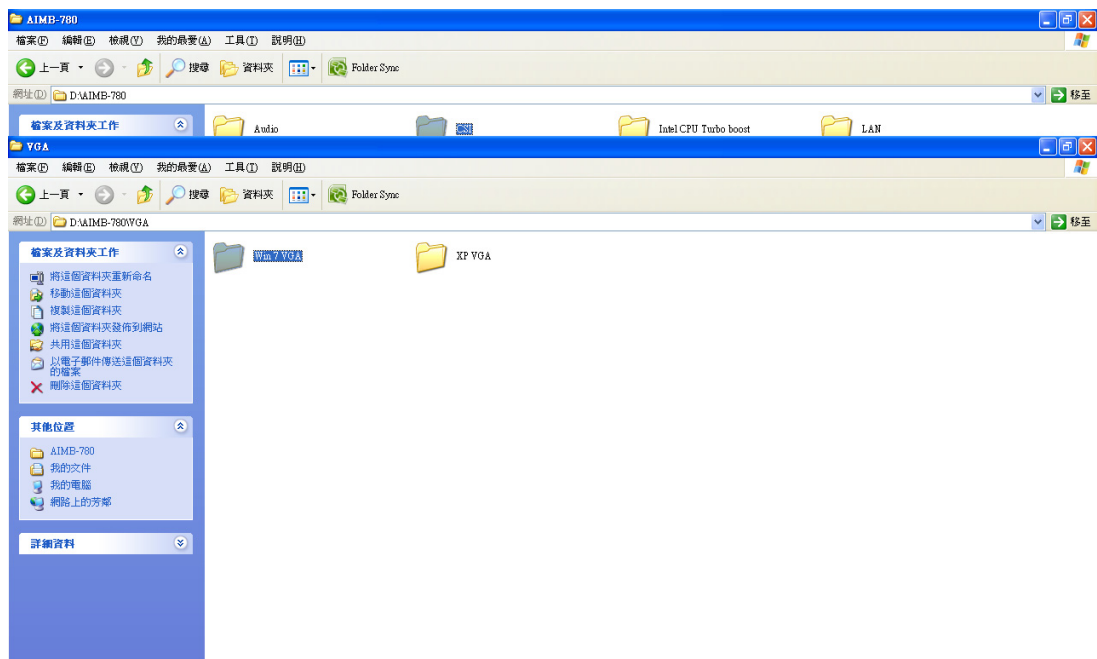

# Chapter 6

## LAN Configuration

## 6.1 Introduction

The AIMB-780 has dual Gigabit Ethernet LANs via dedicated PCI Express x1 lanes (Intel 82578DM (LAN1) and 82583V (LAN2)) that offer bandwidth of up to 500 MB/sec, eliminating the bottleneck of network data flow and incorporating Gigabit Ethernet at 1000 Mbps.

## 6.2 Features

- 10/100/1000Base-T Ethernet controller
- 10/100/1000Base-T triple-speed MAC
- Full duplex at 10, 100, or 1000 Mbps and half duplex at 10 or 100 Mbps
- Wake-on-LAN (WOL) support
- PCIe x1 host interface

## 6.3 Installation

**Note!** Before installing the LAN drivers, make sure the CSI utility have been installed on your system. See Chapter 4 for information on installing the CSI utility.



The integrated Intel gigabit Ethernet controller supports all major network operating systems. However, the installation procedure varies with different operating systems. In the following sections, refer to the one that provides the driver setup procedure for the operating system you are using.

## 6.4 Win XP /Win 7 Driver Setup (LAN)

Insert the driver CD into your system's CD-ROM drive. Select the LAN folder then click the proper Lan driver for the OS.

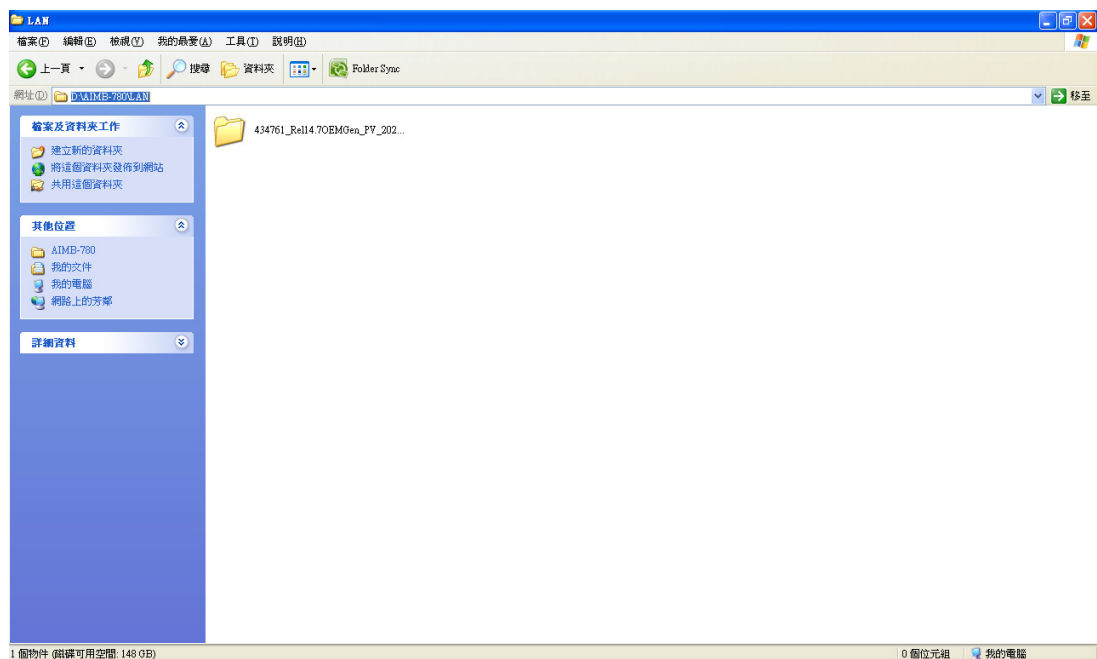

# Appendix **A**

Programming the  
Watchdog Timer

---

The AIMB-780's watchdog timer can be used to monitor system software operation and take corrective action if the software fails to function within the programmed period. This section describes the operation of the watchdog timer and how to program it.

## A.1 Watchdog timer overview

The watchdog timer is built in to the super I/O controller W83627DHG-P. It provides the following functions for user programming:

- Can be enabled and disabled by user's program
- Timer can be set from 1 to 255 seconds or 1 to 255 minutes
- Generates an interrupt or resets signal if the software fails to reset the timer before time-out

## A.2 Programming the Watchdog Timer

The I/O port address of the watchdog timer is 2E (hex) and 2F (hex). 2E (hex) is the address port. 2F (hex) is the data port. You must first write an address value into address port 2E (hex), and then write/read data to/from the assigned register through data port 2F (hex).



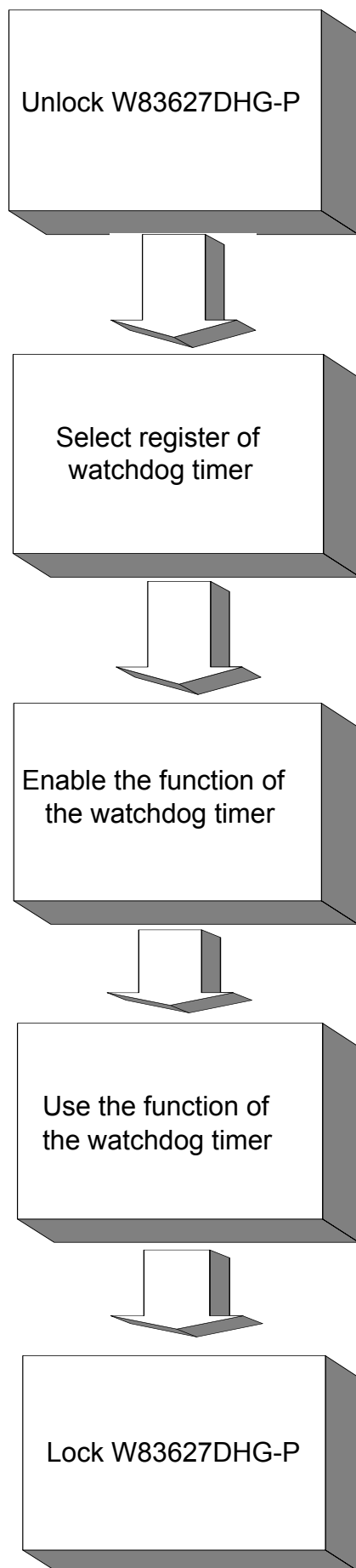

**Table A.1: Watchdog timer registers**

Address of register (2E)	Read/Write	Value (2F) & description
87 (hex)	-	Write this address to I/O address port 2E (hex) twice to unlock the W83627DHG-P
07 (hex)	write	Write 08 (hex) to select register of watchdog timer.
30 (hex)	write	Write 01 (hex) to enable the function of the watchdog timer. Disabled is set as default.
F5 (hex)	write	Set seconds or minutes as units for the timer. Write 0 to bit 3: set seconds as counting unit. [default]. Write 1 to bit 3: set minutes as counting unit.
F6 (hex)	write	0: stop timer [default] 01 ~ FF (hex): The amount of the count, in seconds or minutes, depends on the value set in register F5 (hex). This number decides how long the watchdog timer waits for strobe before generating an interrupt or reset signal. Writing a new value to this register can reset the timer to count with the new value.
F7 (hex)	read/write	Bit 6: Write 1 to enable keyboard to reset the timer, 0 to disable. [default] Bit 5: Write 1 to generate a timeout signal immediately and automatically return to 0. [default=0] Bit 4: Read status of watchdog timer, 1 means timer is "timeout".
AA (hex)	-	Write this address to I/O port 2E (hex) to lock the watchdog timer 2.

## A.2.1 Example Programs

### Enable watchdog timer and set 10 seconds as the timeout interval

```

;-----
Mov dx,2eh ; Unlock W83627DHG-P
Mov al,87h
Out dx,al
Out dx,al
;-----
Mov al,07h ; Select registers of watchdog timer
Out dx,al
Inc dx
Mov al,08h
Out dx,al
;-----
Dec dx; Enable the function of watchdog timer
Mov al,30h
Out dx,al
Inc dx
Mov al,01h
Out dx,al
;-----
Dec dx ; Set second as counting unit
Mov al,0f5h
Out dx,al

```

```

Inc dx
In al,dx
And al,not 08h
Out dx,al
;-----
Dec dx ; Set timeout interval as 10 seconds and start counting
Mov al,0f6h
Out dx,al
Inc dx
Mov al,10
Out dx,al
;-----
Dec dx ; lock W83627DHG-P
Mov al,0aah
Out dx,al
Enable watchdog timer and set 5 minutes as the timeout interval
;-----
Mov dx,2eh ; unlock W83627DHG-P
Mov al,87h
Out dx,al
Out dx,al
;-----
Mov al,07h ; Select registers of watchdog timer
Out dx,al
Inc dx
Mov al,08h
Out dx,al
;-----
Dec dx ; Enable the function of watchdog timer
Mov al,30h
Out dx,al
Inc dx
Mov al,01h
Out dx,al
;-----
Dec dx ; Set minute as counting unit
Mov al,0f5h
Out dx, al
Inc dx
In al,dx
Or al, 08h
Out dx,al
;-----
Dec dx ; Set timeout interval as 5 minutes and start counting
Mov al,0f6h

```

```

Out dx,al
Inc dx
Mov al,5
Out dx,al
;-----
Dec dx ; lock W83627DHG-P
Mov al,0aah
Out dx,al
Enable watchdog timer to be reset by mouse
;-----
Mov dx,2eh ; unlock W83627DHG-P
Mov al,87h
Out dx,al
Out dx,al
;-----
Mov al,07h ; Select registers of watchdog timer
Out dx,al
Inc dx
Mov al,08h
Out dx,al
;-----
Dec dx ; Enable the function of watchdog timer
Mov al,30h
Out dx,al
Inc dx
Mov al,01h
Out dx,al
;-----
Dec dx ; Enable watchdog timer to be reset by mouse
Mov al,0f7h
Out dx,al
Inc dx
In al,dx
Or al,80h
Out dx,al
;-----
Dec dx ; lock W8362DHG-P
Mov al,0aah
Out dx,al
Enable watchdog timer to be reset by keyboard
;-----
Mov dx,2eh ; unlock W83627DHG-P
Mov al,87h
Out dx,al
Out dx,al

```

```

;-----
Mov al,07h ; Select registers of watchdog timer
Out dx,al
Inc dx
Mov al,08h
Out dx,al
;-----
Dec dx ; Enable the function of watchdog timer
Mov al,30h
Out dx,al
Inc dx
Mov al,01h
Out dx,al
;-----
Dec dx ; Enable watchdog timer to be strobed reset by keyboard
Mov al,0f7h
Out dx,al
Inc dx
In al,dx
Or al,40h
Out dx,al
;-----
Dec dx ; lock W83627DHG-P
Mov al,0aah
Out dx,al
Generate a time-out signal without timer counting
;-----
Mov dx,2eh ; unlock W83627DHG-P
Mov al,87h
Out dx,al
Out dx,al
;-----
Mov al,07h ; Select registers of watchdog timer
Out dx,al
Inc dx
Mov al,08h
Out dx,al
;-----
Dec dx ; Enable the function of watchdog timer
Mov al,30h
Out dx,al
Inc dx
Mov al,01h
Out dx,al
;-----

```

---

```
Dec dx ; Generate a time-out signal
Mov al,0f7h
Out dx,al ;Write 1 to bit 5 of F7 register
Inc dx
In al,dx
Or al,20h
Out dx,al
```

```
;-----
Dec dx ; lock W83627DHG-P
Mov al,0aah
Out dx,al
```

# Appendix **B**

I/O Pin Assignments

## B.1 Floppy Drive Connector (FDD1)

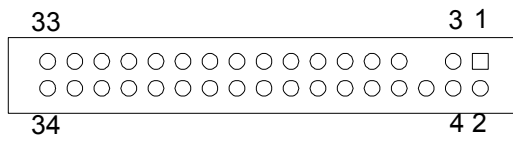

**Table B.1: Floppy drive connector (FDD1)**

Pin	Signal	Pin	Signal
1	GND	2	FDHDIN*
3	GND	4	N/C
5	N/C	6	N/C
7	GND	8	INDEX*
9	GND	10	MOTOR 0*
11	GND	12	N/C
13	GND	14	DRIVE SELECT 0*
15	GND	16	N/C
17	GND	18	DIRECTION*
19	GND	20	STEP*
21	GND	22	WRITE DATA*
23	GND	24	WRITE GATE*
25	GND	26	TRACK 0*
27	GND	28	WRITE PROTECT*
29	GND	30	READ DATA*
31	GND	32	HEAD SELECT*
33	GND	34	DISK CHANGE*

\* low activity



## B.2 Parallel Port (LPT1)

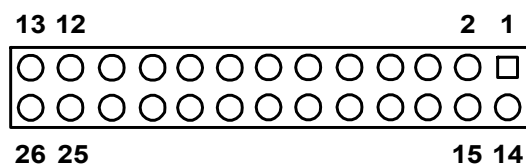

**Table B.2: Parallel Port (LPT1)**

Pin	Signal	Pin	Signal
1	STROBE*	14	AUTOFD*
2	D0	15	ERR*
3	D1	16	INIT*
4	D2	17	SLCTINI*
5	D3	18	GND
6	D4	19	GND
7	D5	20	GND
8	D6	21	GND
9	D7	22	GND
10	ACK*	23	GND
11	BUSY	24	GND
12	PE	25	GND
13	SLCT	26	N/C

## B.3 USB Header (USB56, USB78, USB910, USB1112 & USB1314)

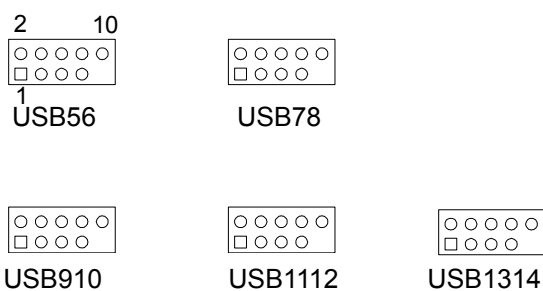

**Table B.3: USB Header (USB56,USB78,USB910,USB1112,USB1314)**

Pin	Signal	Pin	Signal
1	USB_VCC5	2	USB_VCC5
3	USB_D-	4	USB_D-
5	USB_D+	6	USB_D+
7	GND	8	GND
9	Key	10	N/C

## B.4 VGA Connector (VGA1)

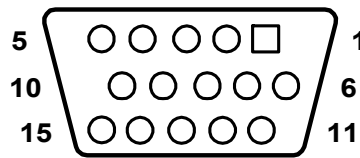

**Table B.4: VGA Connector (VGA1)**

Pin	Signal	Pin	Signal
1	RED	9	VCC
2	GREEN	10	GND
3	BLUE	11	N/C
4	N/C	12	SDT
5	GND	13	H-SYNC
6	GND	14	V-SYNC
7	GND	15	SCK
8	GND		

## B.5 RS-232 Interface (COM3 & COM4)

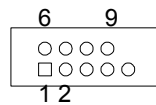

**Table B.5: RS-232 Interface (COM1)**

Pin	Signal
1	DCD
2	RXD
3	TXD
4	DTR
5	GND
6	DSR
7	RTS
8	CTS
9	RI

## B.6 PS/2 Keyboard and Mouse Connector (KBMS1)



**Table B.6: Keyboard and Mouse Connector (KBMS1)**

Pin	Signal
1	KB DATA
2	N/C
3	GND
4	KB VCC
5	KB CLK
6	N/C
7	M_DATA
8	N/C
9	GND
10	M_VCC
11	M_CLK
12	N/C

## B.7 External Keyboard Connector (KBMS2)



**Table B.7: External Keyboard Connector (KBMS2)**

Pin	Signal
1	KB CLK
2	KB DATA
3	MS DATA
4	GND
5	VCC
6	MS CLK

## B.8 Infrared (IR) connector (JIR1)

**Table B.8: Infrared Connector (JIR1)**

Pin	Signal
1	VCC3
2	N/C
3	IRRX
4	GND
5	IRTX

## B.9 CPU/System Fan Power Connector (SYSFAN1/SYSFAN2)

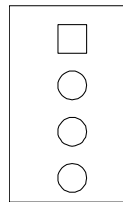

**Table B.9: Fan Power Connector (SYSFAN1/CHAFAN1)**

Pin	Signal
1	GND
2	+12 V
3	DETECT
4	PWM

## B.10 Power LED and Keyboard Lock (JFP3)

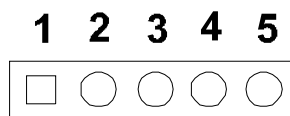

**Table B.10: Power LED and Keyboard Lock (JFP3)**

Pin	Function
1	LED power (+5 V)
2	NC
3	Ground
4	#keylock
5	Ground

## B.11 External Speaker Connector (JFP2)



**Table B.11: External Speaker Connector (JFP2)**

Pin	Function
1	SPK_VCC
4	SPK_OBS
7	SPK_BUZ
10	SPK_OUT

## B.12 Reset Connector (JFP1)

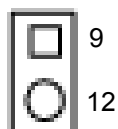

**Table B.12: Reset Connector (JFP1)**

Pin	Signal
9	RESET
12	GND

## B.13 HDD LED Connector (JFP2)

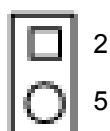

**Table B.13: HDD LED Connector (JFP2)**

Pin	Signal
2	HDD_LED+
5	HDD_LED-

## B.14 ATX Soft Power Switch (JFP1)

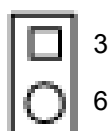

**Table B.14: ATX Soft Power Switch (JFP1)**

Pin	Signal
3	PWR-BTN
2	GND

## B.15 H/W Monitor Alarm (JOBS1)

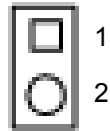

**Table B.15: H/W Monitor Alarm (JOBS1)**

Pin	Signal
1	Error Beep
2	OBS Beep alarm

## B.16 SM Bus Connector (JFP2)

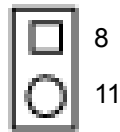

**Table B.16: SM Bus Connector (JFP2)**

Pin	Signal
8	SMB_DATA
11	SMB_CLK

## B.17 USB/LAN ports (LAN1\_USB12 and LAN2\_USB34)

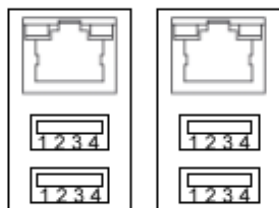

LAN1\_USB12 LAN2\_USB34

**Table B.17: USB Port**

Pin	Signal	Pin	Signal
1	VCC_DUAL	3	Data0+
2	Data0-	4	GND

**Table B.18: Giga LAN 10/100/1000 Base-T RJ-45 port**

Pin	Signal	Pin	Signal
1	MID0+	5	MID2+
2	MID0-	6	MID2-
3	MID1+	7	MID3+
4	MID1-	8	MID3-

## B.18 Line Out, Mic IN Connector (AUDIO1)

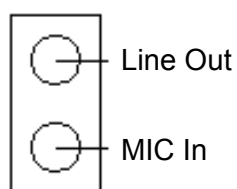

AUDIO1

## B.19 Front Panel Audio Connector (FPAUD1)

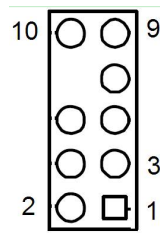

**Table B.19: Front Panel Audio Connector (FPAUD1)**

Pin	Signal
1	MIC2_L
2	AGND
3	MIC2_R
4	PRESENSE
5	LIN2_R
6	MIC_DEC
7	FIO_JD
8	N/A
9	LIN2_L
10	LINEOUT2_DEC

## B.20 8-pin Alarm Board Connector (VOLT1)

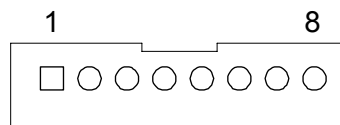
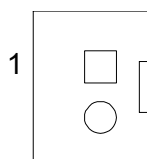

**Table B.20: 8-pin Alarm Board Connector (VOLT1)**

Pin	Signal	Pin	Signal
1	5VSB	5	VCC
2	GND	6	VCC3
3	GND	7	-12V
4	-5V	8	+12V



## B.21 Case Open Connector (JCASE1)



**Table B.21: Case Open Connector (JCASE1)**

Pin	Signal
1	CASEOP
2	GND

## B.22 Front Panel LAN LED Connector (LAN\_LED1)

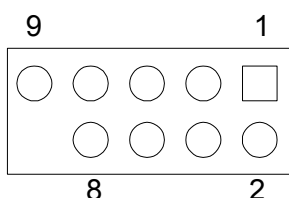

**Table B.22: LAN LED Connector (LANLED1)**

Pin	Signal	Pin	Signal
1	LAN1_LINK/ACT	2	LAN2_LINK/ACT
3	3VDUAL	4	3VDUAL
5	LAN1_LINK1000	6	LAN2_LINK1000
7	LAN1_LINK100	8	LAN2_LINK100
9	3VDUAL	10	N/C

## B.23 SPI\_CN1: SPI fresh card pin connector

**Table B.23: SPI\_CN1:SPI fresh card pin connector**

Pin	Signal	Pin	Signal
1	+3VSB	2	GND
3	SPI_CS#	4	SPI_CLK
5	SPI_MISO	6	SPI_MOSI
7	N/A	8	NC

## B.24 System I/O Ports

**Table B.24: System I/O ports**

Addr. range (Hex)	Device
000-01F	DMA controller
020-021	Interrupt controller 1, master
022-023	Chipset address
040-05F	8254 timer
060-06F	8042 (keyboard controller)
070-07F	Real-time clock, non-maskable interrupt (NMI) mask
080-09F	DMA page register
0A0-0BF	Interrupt controller 2
0C0-0DF	DMA controller
0F0	Clear math co-processor
0F1	Reset math co-processor
0F8-0FF	Math co-processor
1F0-1F8	Fixed disk
290-297	On-board hardware monitor
2F8-2FF	Serial port 2
300-31F	Prototype card
360-36F	Reserved
380-38F	SDLC, bisynchronous 2
3A0-3AF	Bisynchronous 1
3B0-3BF	Monochrome display and printer adapter (LPT1)
3C0-3CF	Reserved
3D0-3DF	Color/graphics monitor adapter
3F0-3F7	Diskette controller
3F8-3FF	Serial port 1

## B.25 DMA Channel Assignments

**Table B.25: DMA channel assignments**

Channel	Function
0	Available
1	Available
2	Floppy disk (8-bit transfer)
3	Available
4	Cascade for DMA controller 1
5	Available
6	Available
7	Available

## B.26 Interrupt Assignments

**Table B.26: Interrupt assignments**

Priority	Interrupt#	Interrupt source
1	NMI	Parity error detected
2	IRQ0	Interval timer
3	IRQ1	Keyboard
-	IRQ2	Interrupt from controller 2 (cascade)
4	IRQ8	Real-time clock
5	IRQ9	Cascaded to INT 0A (IRQ 2)
6	IRQ10	Available/Serial communication port 4
7	IRQ11	Available
8	IRQ12	PS/2 mouse
9	IRQ13	INT from co-processor
10	IRQ14	Primary IDE Channel
11	IRQ15	Secondary IDE Channel
12	IRQ3	Serial communication port 2
13	IRQ4	Serial communication port 1
14	IRQ5	Serial communication port 3
15	IRQ6	Diskette controller (FDC)
16	IRQ7	Parallel port 1 (print port)

## B.27 1st MB Memory Map

**Table B.27: 1st MB memory map**

Addr. range (Hex)	Device
E0000h - FFFFFh	BIOS
CC000h - DFFFFh	Unused
C0000h - CBFFFh	VGA BIOS
A0000h - BFFFFh	Video Memory
00000h - 9FFFFh	Base memory

*Trusted ePlatform Services*

**ADVANTECH**

**[www.advantech.com](http://www.advantech.com)**

Please verify specifications before quoting. This guide is intended for reference purposes only.

All product specifications are subject to change without notice.

No part of this publication may be reproduced in any form or by any means, electronic, photocopying, recording or otherwise, without prior written permission of the publisher.

All brand and product names are trademarks or registered trademarks of their respective companies.

© Advantech Co., Ltd. 2010