

Data sheet | Item number: 770-1324
Socket; 4-pole; Cod. Q; 4,00 mm²; green

www.wago.com/770-1324

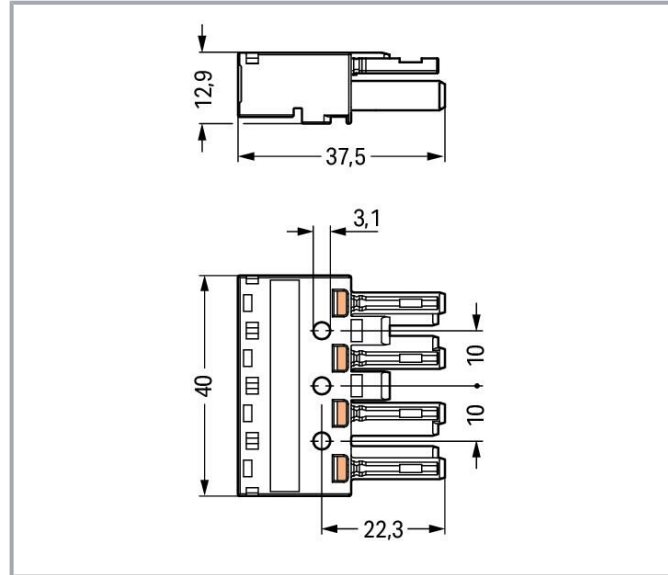
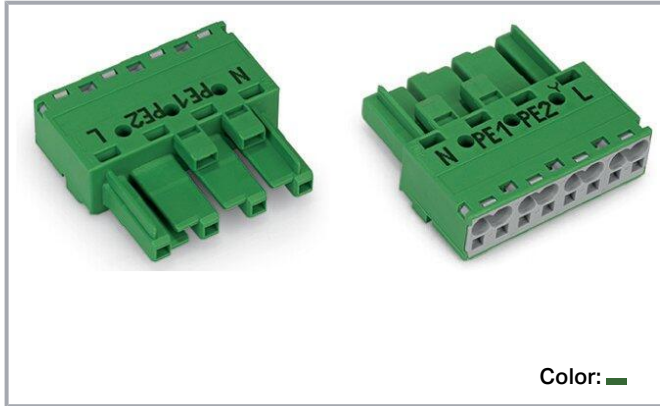

Item description

Female connector/socket WINSTA® MIDI Q coding

The WINSTA® MIDI female connector/socket with protection type IP20 is the pluggable solution for your application in control cabinets, on PCBs or for lighting connections. WAGO pluggable installation connectors are useful when criteria repeat or are distributed on a specified pattern, for example for installing grid lighting or flush-mount lighting. The coding options reduce installation errors, allowing fast, maintenance-free wiring of all components. The pluggable installation connector is protected in accordance with protection type IP20 (When mated and secured with a strain relief housing: IP2xC (These compact connectors are not designed for use in open, easily accessible areas!)). This means that users' fingers will never come into contact with electrified elements. Important parameters in the selection of a pluggable installation connector are the rated current and voltage: They provide information about possible domains of use and applications. This product has a current rating of 32 A – therefore it is suitable for robust loads. The WINSTA® MIDI Pluggable Connection System with Push-in CAGE CLAMP® spring pressure connection technology facilitates safe electrification. Due to the included test slot, it is possible to check connections even when they are plugged in. This saves time, labor, and money.

Push-in CAGE CLAMP® spring pressure connection technology – pluggable installation instead of laborious screw connections!

Subject to changes. Please also observe the further product documentation!

WAGO GmbH & Co. KG
Hansastr. 27
32423 Minden
Phone: +49571 887-0 | Fax: +49571 887-169
Email: info.de@wago.com | Web: www.wago.com

Do you have any questions about our products?
We are always happy to take your call at +49 (571) 887-44222.



WINSTA® is the pluggable connection system that is optimally tailored to the strict requirements of electrical installation. It ensures error-free installation of cables and components, quickly and reliably. Choose durability and quality – the WINSTA® MIDI pluggable installation connector with protection type IP20 from WAGO makes the installation of electrical components significantly easier.

- protection against mismatching eliminates errors
- pre-assembled versions
- ready for immediate use
- convenient installation and commissioning

Data

Electrical data

Ratings per IEC/EN

Ratings per	IEC/EN 60664-1
Nominal voltage (III/3)	400 V
Rated impulse voltage (III/3)	6 kV
Rated current	32 A
Legend (ratings)	(III / 3) ≙ Overvoltage category III / Pollution degree 3

Ratings per UL 1977

Note for the US market	Some versions may also be used for current interruption in accordance with the UL certificate in select applications with currents below 16 A and voltages up to 600 V. For further information, please contact your local sales office.
Rated voltage (UL 1977)	600 V
Rated current UL 1977	23 A

General

Note on contact resistance	approx. 1 mΩ of contact resistance approx. 0.25 mΩ contact transition plug/socket
----------------------------	--

Connection data

Connection points	4
Total number of potentials	4

Subject to changes. Please also observe the further product documentation!



Connection 1

Connection technology	Push-in CAGE CLAMP®
Actuation type	Operating tool Push-in
Nominal cross-section	4 mm ² / 12 AWG
Solid conductor	0.5 ... 4 mm ² / 20 ... 12 AWG
Solid conductor; push-in termination	1.5 ... 4 mm ² / 16 ... 12 AWG
Stranded conductor	0.5 ... 2.5 mm ² / 20 ... 14 AWG
Fine-stranded conductor	0.5 ... 4 mm ² / 20 ... 12 AWG
Fine-stranded conductor; with insulated ferrule	0.25 ... 1.5 mm ² / 20 ... 16 AWG
Fine-stranded conductor; with uninsulated ferrule	0.25 ... 2.5 mm ² / 20 ... 14 AWG
Fine-stranded conductor; with ferrule; push-in termination	1.5 mm ² / 16 AWG
Strip length	9 mm / 0.35 inches
Pole number	4
Conductor entry direction to mating direction	0°

Physical data

Pin spacing	10 mm / 0.394 inches
Width	40 mm / 1.575 inches
Height	12.9 mm / 0.508 inches
Depth	37.5 mm / 1.476 inches

Mechanical Data

Application	for "Clean Ground" applications
Coding	Q
Variable coding	No
Marking	N PE1 PE2 L
Potential marking	N PE1 PE2 L
Mating force of a plug-in connection	approx. 20 ... 70 N (depending on pole number)
Retention force of a plug-in connection	Locked: > 80 N
Unmating force of a plug-in connection	Unlocked: approx. 20 ... 70 N (depending on pole number)
Number of mating cycles	200, without resistive load
Protection type	IP20; When mated and secured with a strain relief housing: IP2xC (These compact connectors are not designed for use in open, easily accessible areas!)

Subject to changes. Please also observe the further product documentation!



Plug-in connection

Contact type (pluggable connector)	Female connector/socket
Connector (connection type)	for conductor
Mismating protection	Yes
Note on mismating protection	All WINSTA [®] components are 100% protected against mismating when: a.) plugging different numbers of poles b.) plugging while rotated 180 c.) plugging while laterally staggered d.) plugging one pole
Locking lever	Can be retrofitted
Locking of plug-in connection	locking lever
Note on locking system	All connectors for mounted installations (snap-in versions for lighting fixtures or devices, all types of PCB and distribution connectors) are factory-equipped with locking levers to ensure plugs and sockets are securely locked. Additional locking levers are only required for flying leads (plug/socket).

Material Data

Note (material data)	Information on material specifications can be found here
Color	green
Cover color	gray
Material group	I
Insulation material	Polyamide (PA66)
Flammability class per UL94	V0
Clamping spring material	Chrome-nickel spring steel (CrNi)
Contact material	Copper or copper alloy; surface-treated
Contact plating	Tin
Fire load	0.221 MJ
Weight	12.6 g

Environmental requirements

Processing temperature	-5 ... +40 °C
Continuous operating temperature	-35 ... +85 °C
Note on continuous operating temperature	Insulating parts for temperatures ≤ 105 °C

Subject to changes. Please also observe the further product documentation!

Commercial data



eCl@ss 10.0	27-44-06-05
eCl@ss 9.0	27-44-06-05
ETIM 8.0	EC002560
ETIM 7.0	EC002560
PU (SPU)	50 pcs
Packaging type	box
Country of origin	DE
GTIN	4045454299156
Customs tariff number	85366990990

Environmental Product Compliance

RoHS Compliance Status	Compliant, No Exemption
------------------------	-------------------------

Approvals / Certificates

General approvals

Logo	Approval	Additional Approval Text	Certificate name
	CCA DEKRA Certification B.V.	EN 61535	71-123228
	CCA DEKRA Certification B.V.	IEC 61535	NL -84761
	cURus Underwriters Laboratories Inc.	UL 1977	E45171

Declarations of conformity and manufacturer's declarations

Logo	Approval	Additional Approval Text	Certificate name
	EU-Declaration of Conformity WAGO GmbH & Co. KG	-	-



Approvals for marine applications

Certificate



Subject to changes. Please also observe the further product documentation!

WAGO GmbH & Co. KG
 Hansastr. 27
 32423 Minden
 Phone: +49571 887-0 | Fax: +49571 887-169
 Email: info.de@wago.com | Web: www.wago.com

Do you have any questions about our products?
 We are always happy to take your call at +49 (571) 887-44222.





Logo	Approval	Additional Approval Text	name
	ABS American Bureau of Shipping	-	19- HG1868589- PDA
	DNV GL Det Norske Veritas, Germanischer Lloyd	-	TAE00001Z6
	LR Lloyds Register	IEC 61984	LR22429487TA

Counterpart

	Item no.770-1334 Plug; 4-pole; Cod. Q; 4,00 mm ² ; green	www.wago.com/770-1334
	Item no.770-2334 Snap-in plug; 4-pole; Cod. Q; 4,00 mm ² ; green	www.wago.com/770-2334
	Item no.770-2334/007-000 Snap-in plug; with direct ground contact; 4-pole; Cod. Q; 4,00 mm ² ; green	www.wago.com/770-2334/007-000

Required accessories

Strain relief

Strain relief housing		
	Item no.: 770-504/023-000 Strain relief housing; 4-pole; for 2 cables; 5.0 ... 9.0 mm; 55 mm; black	www.wago.com/770-504/023-000
	Item no.: 770-514 Strain relief housing; 4-pole; for 2 cables; 9.0 ... 13.0 mm; 55 mm; white	www.wago.com/770-514
	Item no.: 770-504 Strain relief housing; 4-pole; for 2 cables; 9.0 ... 13.0 mm; 55 mm; black	www.wago.com/770-504
	Item no.: 770-514/023-000 Strain relief housing; 4-pole; for 2 cables; 5.0 ... 9.0 mm; 55 mm; white	www.wago.com/770-514/023-000

Locking levers

Locking system

Subject to changes. Please also observe the further product documentation!



Item no.: 770-121
Locking lever; for flying leads; for manual operation; white

www.wago.com/770-121



Item no.: 770-131
Locking lever; for flying leads; for tool operation; white

www.wago.com/770-131



Item no.: 770-101
Locking lever; for flying leads; for manual operation; black

www.wago.com/770-101



Item no.: 770-111
Locking lever; for flying leads; for tool operation; black

www.wago.com/770-111

Cover

Cover



Item no.: 770-201
Lockout cap; 12-pole, separable; for sockets; Plastic; black

www.wago.com/770-201



Item no.: 770-221
Lockout cap; 12-pole, separable; for sockets; Plastic; white

www.wago.com/770-221

Optional accessories

Mounting

Snap-in frame



Item no.: 770-319
Snap-in frame; 4-pole; 1.0 ... 3.0 mm; black

www.wago.com/770-319



Item no.: 770-339
Snap-in frame; 4-pole; 1.0 ... 3.0 mm; black

www.wago.com/770-339

Cover

Cover



Item no.: 897-2005
Protective cap; Type4; for sockets and plugs; PVC; red

www.wago.com/897-2005

Tool

Operating tool

Subject to changes. Please also observe the further product documentation!



Item no.: 210-719

Operating tool; Blade: 2.5 x 0.4 mm; with a partially insulated shaft

Marking accessories

Marker



Item no.: 770-450/000-002
Marker card; Plastic; yellow

www.wago.com/770-450/000-002



Item no.: 770-450/000-001
Marker card; Plastic; green

www.wago.com/770-450/000-001



Item no.: 770-450/000-005
Marker card; Plastic; red

www.wago.com/770-450/000-005



Item no.: 770-450
Marker card; Plastic; white

www.wago.com/770-450



Item no.: 770-450/000-006
Marker card; Plastic; blue

www.wago.com/770-450/000-006



Item no.: 770-450/000-012
Marker card; Plastic; orange

www.wago.com/770-450/000-012

Downloads

Documentation

Bid Text

770-1324 X81 - Datei	2019 Feb 19	xml 3.1 kB	Download
770-1324 doc - Datei	2015 Jun 8	doc 24.1 kB	Download

Subject to changes. Please also observe the further product documentation!

CAD/CAE-Data

CAE data

EPLAN Data Portal 770-1324	URL	Download
WSCAD Universe 770-1324	URL	Download
ZUKEN Portal 770-1324	URL	Download

CAD data

2D/3D Models 770-1324	URL	Download
-----------------------	---------------------	--------------------------

Environmental Product Compliance

Compliance Search

Environmental Product Compliance 770-1324 Socket; 4-pole; Cod. Q; 4,00 mm ² ; green	URL	Download
---	---------------------	--------------------------

Installation Notes

Conductor termination

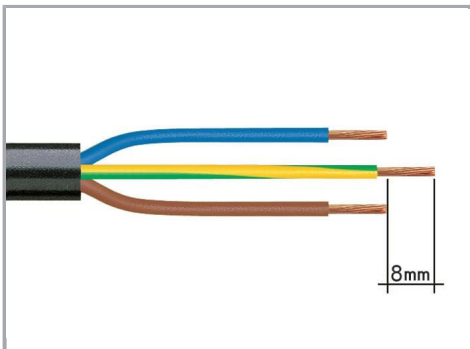

1. Strip length, outer insulation = 35 mm (2-pole), 55 mm (3- to 5-pole)
2. Strip length = 9 mm
3. Extended ground conductor = 8 mm

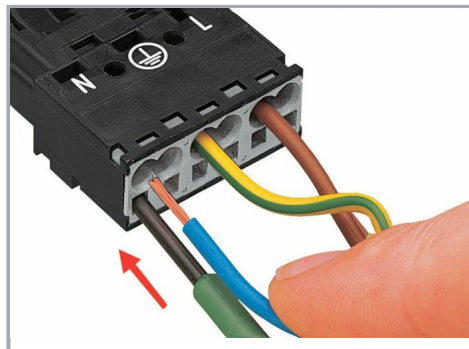

To terminate fine-stranded conductors, open the clamping unit via screwdriver (2.5 mm blade width) and insert a stripped conductor until it hits the backstop.

Subject to changes. Please also observe the further product documentation!

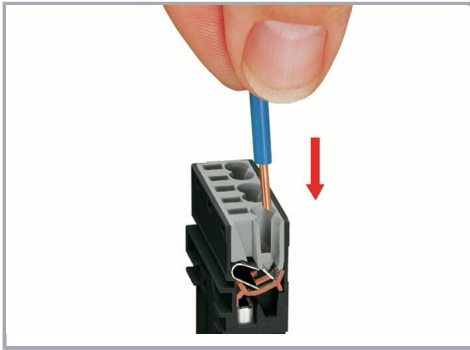

Insert the stripped solid conductor until it hits the backstop.

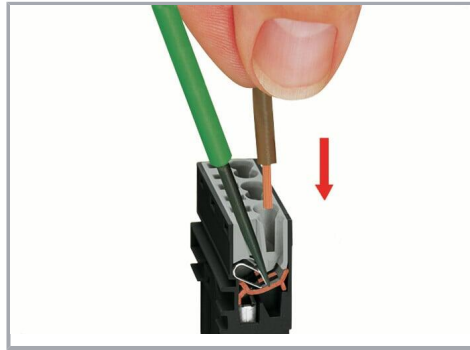

To terminate fine-stranded conductors, open the clamping unit via screwdriver (2.5 mm blade width) and insert a stripped conductor until it hits the backstop.

Conductor removal

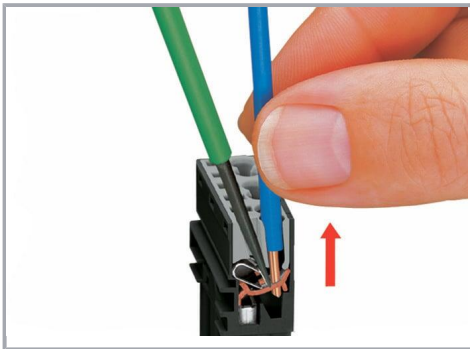

To remove the conductor, actuate the clamp via screwdriver (2.5 mm blade width) and pull out the conductor.

Installation

Subject to changes. Please also observe the further product documentation!

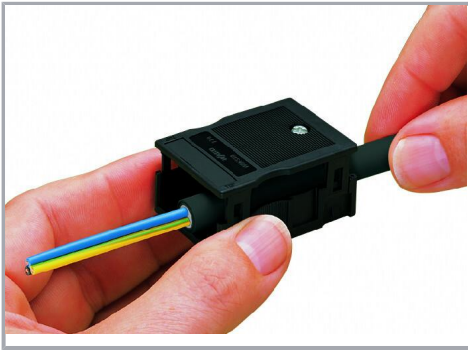

We recommend pulling the pre-latched strain relief housing over the cable prior to termination. However, the strain relief can be mounted at a later time as well.

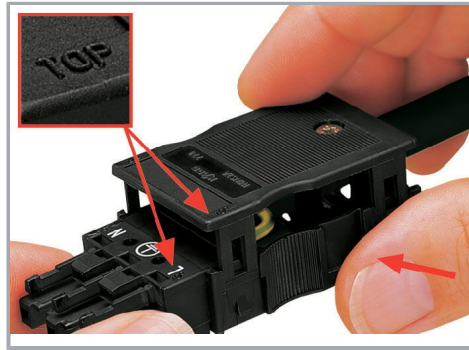

Latch the strain relief housing onto the plug /socket. Note the "TOP" inscription.

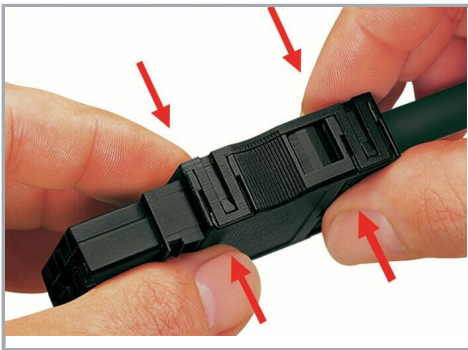

Prepare strain relief housing by snapping together upper and bottom part.



Tighten strain relief screw with screwdriver (2.5 mm blade width).

Product family

WINSTA® MIDI

[Show all products from the family](#)

Subject to changes. Please also observe the further product documentation!