

Data sheet | Item number: 770-621

T-distribution connector; 5-pole; Cod. A; 1 input; 2 outputs; 2 locking levers;
black



www.wago.com/770-621



Color: ■

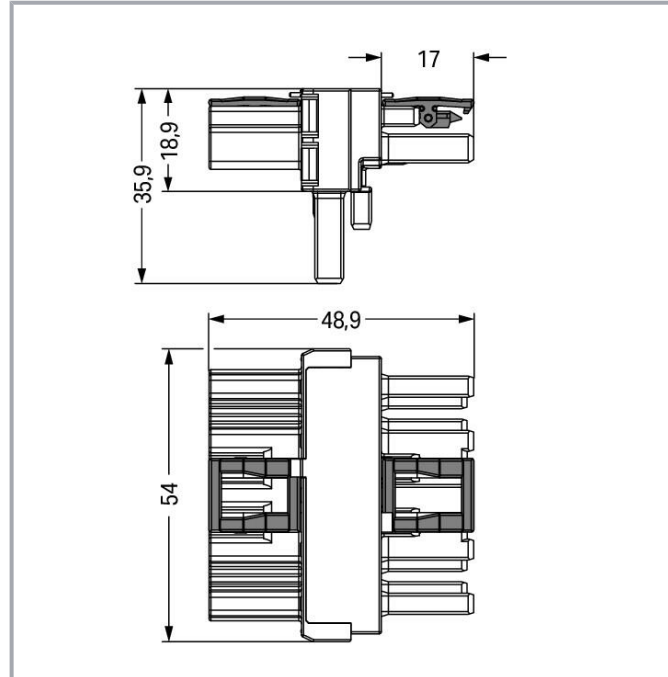

Item description

Distribution connector *WINSTA*® MIDI with protection type IP20

For power and signal transmission: The *WINSTA*® MIDI distribution connector with protection type IP20. WAGO pluggable installation connectors are useful when specifications repeat or are distributed on a specified grid, for example for installing grid lighting or flush-mount lighting. For greater security in electrical installations, the pluggable installation connector is equipped with mechanical protection against mismatching. The pluggable installation connector is protected against ingress by solid objects in accordance with protection type IP20 (When mated: IP2xC (These compact connectors are not designed for use in open, easily accessible areas!)). General mains applications for almost any domain of use can be implemented with *WINSTA*® MIDI pluggable installation connectors with A coding. This pluggable installation connector can be used for a voltage load of up to 25 A. Thus, it can also be used for high power loads. *WINSTA*® MIDI with Push-in CAGE CLAMP® spring pressure connection technology is used in can be found in a variety of projects you can use for quick, easy, flexible, and secure installation.

Lower costs through fast commissioning and elimination of service expenses – solutions from *WINSTA*® MIDI

Subject to changes. Please also observe the further product documentation!

WAGO GmbH & Co. KG
Hansastr. 27
32423 Minden
Phone: +49571 887-0 | Fax: +49571 887-169
Email: info.de@wago.com | Web: www.wago.com

Do you have any questions about our products?
We are always happy to take your call at +49 (571) 887-44222.



WINSTA® is the pluggable connection system that is ideally tailored to the strict requirements of electrical installation. It ensures error-free installation of cables and components, quickly and reliably. Choose quality and durability – the WINSTA® MIDI pluggable installation connector with marking from WAGO makes the installation of electrical components noticeably easier.

- protection against mismatching eliminates errors
- simple circuits
- with A coding for a large number of applications
- ready for immediate use
- quick replacement of defective units during ongoing operation

Data

Electrical data

Ratings per IEC/EN

Ratings per	IEC/EN 60664-1
Nominal voltage (III/3)	400 V
Rated impulse voltage (III/3)	6 kV
Rated current	25 A
Legend (ratings)	(III / 3) ≙ Overvoltage category III / Pollution degree 3

Ratings per UL 1977

Note for the US market	Some versions may also be used for current interruption in accordance with the UL certificate in select applications with currents below 16 A and voltages up to 600 V. For further information, please contact your local sales office.
Rated voltage (UL 1977)	600 V
Rated current UL 1977	23 A

General

Note on contact resistance	approx. 1 mΩ of contact resistance approx. 0.25 mΩ contact transition plug/socket
----------------------------	--

Connection data

Total number of potentials	5
PE function	Preceding PE contact

Subject to changes. Please also observe the further product documentation!

Connection 1

Pole number	5
-------------	---

Physical data

Pin spacing	10 mm / 0.394 inches
Width	54 mm / 2.126 inches
Height	35.9 mm / 1.413 inches
Depth	48.9 mm / 1.925 inches

Mechanical Data

Application	General mains applications
Coding	A
Marking	L3 L2 L1 \perp N
Potential marking	L3 L2 L1 \perp N
Mating force of a plug-in connection	approx. 20 ... 70 N (depending on pole number)
Retention force of a plug-in connection	When locked: > 80 N
Unmating force of a plug-in connection	Unlocked: approx. 20 ... 70 N (depending on pole number)
Number of mating cycles	200, without resistive load
Type of distribution box	T-distribution connector
Protection type	IP20; When mated: IP2xC (These compact connectors are not designed for use in open, easily accessible areas!)

Plug-in connection

Contact type (pluggable connector)	Socket/plug
Mismating protection	Yes
Note on mismating protection	All WINSTA [®] components are 100% protected against mismating when: a.) plugging different numbers of poles b.) plugging while rotated 180 c.) plugging while laterally staggered d.) plugging one pole
Locking lever	yes
Locking of plug-in connection	locking lever
Note on locking system	All connectors for mounted installations (snap-in versions for lighting fixtures or devices, all types of PCB and distribution connectors) are factory-equipped with locking levers to ensure plugs and sockets are securely locked. Additional locking levers are only required for flying leads (plug/socket).

Subject to changes. Please also observe the further product documentation!



Material Data

Note (material data)

Information on material specifications can be found here

Color	black
Insulation material	Polyamide (PA66)
Flammability class per UL94	V0
Contact material	Copper or copper alloy; surface-treated
Contact plating	Tin
Fire load	0.503 MJ
Weight	25.4 g

Environmental requirements

Processing temperature	-5 ... +40 °C
Continuous operating temperature	-35 ... +85 °C
Note on continuous operating temperature	Insulating parts for temperatures ≤ 105 °C

Commercial data

eCl@ss 10.0	27-44-06-03
eCl@ss 9.0	27-44-06-03
ETIM 8.0	EC002567
ETIM 7.0	EC002567
PU (SPU)	50 pcs
Packaging type	box
Country of origin	DE
GTIN	4044918935005
Customs tariff number	85366990990

Environmental Product Compliance

RoHS Compliance Status	Compliant, No Exemption
------------------------	-------------------------

Approvals / Certificates

General approvals

Logo	Approval	Additional Approval Text	Certificate name
	CCA DEKRA Certification B.V.	EN 61535	71- 123228

Subject to changes. Please also observe the further product documentation!

WAGO GmbH & Co. KG
Hansastr. 27
32423 Minden
Phone: +49571 887-0 | Fax: +49571 887-169
Email: info.de@wago.com | Web: www.wago.com

Do you have any questions about our products?
We are always happy to take your call at +49 (571) 887-44222.



CCA DEKRA Certification B.V.	IEC 61535	NL -84761
---------------------------------	-----------	-----------





cURus Underwriters Laboratories Inc.	UL 1977	E45171
---	---------	--------

Declarations of conformity and manufacturer's declarations

Logo	Approval	Additional Approval Text	Certificate name
	EU-Declaration of Conformity WAGO GmbH & Co. KG	-	-

Approvals for marine applications

Logo	Approval	Additional Approval Text	Certificate name
	ABS American Bureau of Shipping	-	19- HG1868589- PDA
	DNV GL Det Norske Veritas, Germanischer Lloyd	-	TAE00001Z6
	LR Lloyds Register	IEC 61984	LR22429487TA

Counterpart



Item no.770-105
Socket; with strain relief housing; 5-pole; Cod. A; 4,00 mm²; black

www.wago.com/770-105











Item no.770-115
Plug; with strain relief housing; 5-pole; Cod. A; 4,00 mm²; black

www.wago.com/770-115

Subject to changes. Please also observe the further product documentation!

WAGO GmbH & Co. KG
Hansastr. 27
32423 Minden
Phone: +49571 887-0 | Fax: +49571 887-169
Email: info.de@wago.com | Web: www.wago.com

Do you have any questions about our products?
We are always happy to take your call at +49 (571) 887-44222.

	Item no.770-205 Socket; 5-pole; Cod. A; 4,00 mm ² ; black	www.wago.com/770-205
	Item no.770-215 Plug; 5-pole; Cod. A; 4,00 mm ² ; black	www.wago.com/770-215
	Item no.770-315 Plug; with strain relief housing; 5-pole; Cod. A; 4,00 mm ² ; black	www.wago.com/770-315
	Item no.770-305 Socket; with strain relief housing; 5-pole; Cod. A; 4,00 mm ² ; black	www.wago.com/770-305
	Item no.770-405 Socket; 5-pole; Cod. A; 4,00 mm ² ; black	www.wago.com/770-405
	Item no.770-415 Plug; 5-pole; Cod. A; 4,00 mm ² ; black	www.wago.com/770-415
	Item no.771-9995/006-101 pre-assembled interconnecting cable; Eca; Socket/plug; 5-pole; Cod. A; H05VV-F 5G 1.5 mm ² ; 1 m; 1,50 mm ² ; black	www.wago.com/771-9995/006-101
	Item no.771-9995/206-101 pre-assembled connecting cable; Eca; Plug/open-ended; 5-pole; Cod. A; H05VV-F 5G 1.5 mm ² ; 1 m; 1,50 mm ² ; black	www.wago.com/771-9995/206-101
	Item no.771-9995/106-101 pre-assembled connecting cable; Eca; Socket/open-ended; 5-pole; Cod. A; H05VV-F 5G 1.5 mm ² ; 1 m; 1,50 mm ² ; black	www.wago.com/771-9995/106-101

Optional accessories



Mounting

Mounting accessories

	Item no.: 770-354 Mounting plate; 2- to 5-pole; for distribution connectors; silver-colored	www.wago.com/770-354
--	---	--

Cover

Cover

	Item no.: 770-360 Lockout cap; for plugs; 5-pole; separable; yellow	www.wago.com/770-360
	Item no.: 770-201 Lockout cap; 12-pole, separable; for sockets; Plastic; black	www.wago.com/770-201
	Item no.: 770-221 Lockout cap; 12-pole, separable; for sockets; Plastic; white	www.wago.com/770-221

Subject to changes. Please also observe the further product documentation!



Downloads

Documentation

Bid Text

770-621 X81 - Datei	2019 Feb 19	xml 2.8 kB	Download
770-621 doc - Datei	2014 Dec 10	doc 23.6 kB	Download
ausschreiben.de 770-621		URL	Download

CAD/CAE-Data

CAD data

2D/3D Models 770-621		URL	Download
----------------------	--	-----	----------

CAE data

EPLAN Data Portal 770-621		URL	Download
WSCAD Universe 770-621		URL	Download
ZUKEN Portal 770-621		URL	Download

Environmental Product Compliance

Compliance Search

Environmental Product Compliance 770-621 T-distribution connector; 5-pole; Cod. A; 1 input; 2 outputs; 2 locking levers; black		URL	Download
---	--	-----	----------

Installation Notes

Installation

Subject to changes. Please also observe the further product documentation!

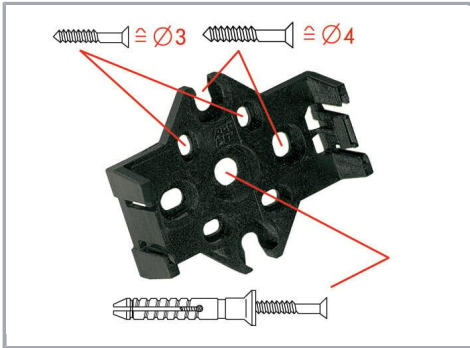

Mounting plates can be secured using commercially available screws or nail-drive anchors.



The distribution connectors snap together when attached to the mounting plate.



To release the distribution connector, unlock the latch using a screwdriver.

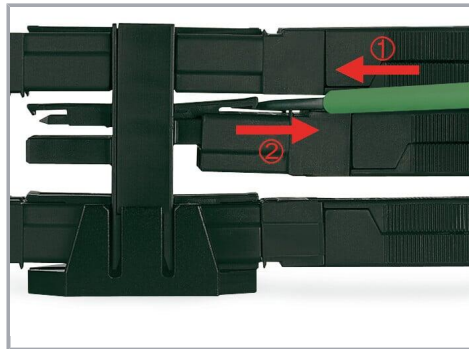

All distribution connector connections are locked and protected against accidental disconnection directly after mating. Locking of any connection is released using a screwdriver, even if all connections are used.

Product family

WINSTA® MIDI

[Show all products from the family](#)

Subject to changes. Please also observe the further product documentation!