

Data sheet | Item number: 2857-569

Single-Phase Power Signal Conditioner; Current and voltage input signal;
 Current and voltage output signal; Digital output; Configuration via software;
 Supply voltage: 24 VDC

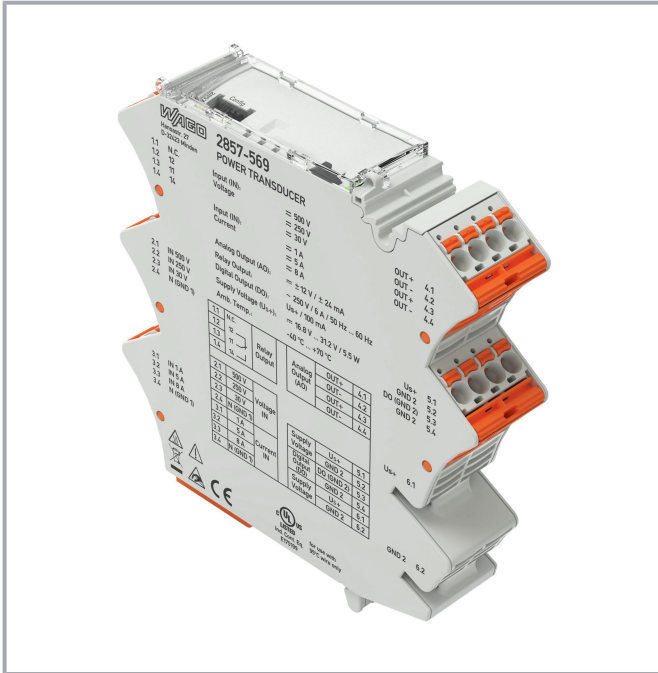

www.wago.com/2857-569



1.1	N.C.	Relay Output	Analog Output (AO)	OUT+	4.1	
1.2	12			OUT-	4.2	
1.3	11			OUT+	4.3	
1.4	14			OUT-	4.4	
2.1	500 V	Voltage IN	Supply Voltage	U _s +	5.1	
2.2	250 V			GND 2	5.2	
2.3	30 V			Digital Output (DO)	DO (GND 2)	5.3
2.4	N (GND 1)				GND 2	5.4
3.1	1 A	Current IN	Supply Voltage	U _s +	6.1	
3.2	5 A			GND 2	6.2	
3.3	8 A					
3.4	N (GND 1)					

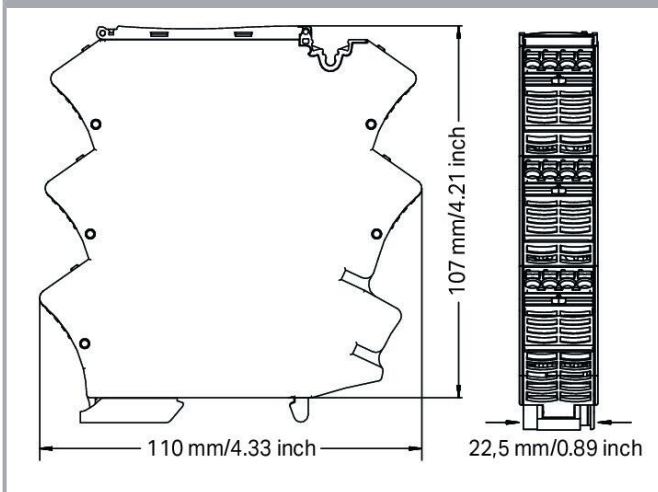

Item description

Short description:

WAGO's 1-phase power measurement module monitors and reports signal states with up to two switching thresholds. The sensor and status information that is collected is also converted to a standard analog signal. Current, voltage, effective power, apparent power or reactive power can be selected as the measured variable.

Subject to changes. Please also observe the further product documentation!

WAGO GmbH & Co. KG
 Hansastr. 27
 32423 Minden
 Phone: +49571 887-0 | Fax: +49571 887-169
 Email: info.de@wago.com | Web: www.wago.com

Do you have any questions about our products?
 We are always happy to take your call at +49 (571) 887-44222.

Additionally, both frequency and phase angle are displayed.

Features:

- A relay with changeover contact reacts to configured measurement range limits (on/off switching delay and threshold value switch function can be configured with up to two threshold values).
- Adjustable software filter
- Simulation of input/output response via WAGO Interface Configuration Display
- Analog unipolar/bipolar signals (current/voltage) at output
- Additional digital signal output for configured measurement range limits
- The digital output can be configured as a frequency generator or pulse output (S0 interface).

Data

Notes

Note

- This product is supplied with 24 VDC, which can be commoned using lateral push-in type jumper bars: (6.1) U_S^+ (BR) and (6.2) GND 2 (BR). With this variant, it is necessary to ensure that the maximum permissible total current of 6 A is not exceeded.
- Additional setting options via WAGO Interface Configuration Software or WAGO Configuration Display

Technical data

Configuration

Configuration options

WAGO Interface Configuration Software
WAGO Configuration Display

Input

Input signal type	Voltage Current
Input signal (voltage)	AC/DC 500 V (IN 2.1; per EN 61010-1); AC/DC 300 V (IN 2.1; per UL 61010-1); AC/DC 250 V (IN 2.2); 30 V AC/DC (IN 2.3)
Input signal (current)	AC/DC 1 A (IN 3.1); AC/DC 5 A (IN 3.2); 8 A AC/DC (IN 3.3)
Frequency range	15 ... 400 Hz
Input current (max.)	$1.2 \times I_N$ ($\leq 60^\circ\text{C}$); $1 \times I_N$ (60 ... 70 °C)
Input voltage (max.)	$1.2 \times U_N$

Subject to changes. Please also observe the further product documentation!

WAGO GmbH & Co. KG

Hansastr. 27

32423 Minden

Phone: +49571 887-0 | Fax: +49571 887-169

Email: info.de@wago.com | Web: www.wago.com

Do you have any questions about our products?

We are always happy to take your call at +49 (571) 887-44222.



Response threshold (voltage)	500 mVAC / 600 mVDC (IN 2.1) 50 mVAC / 500 mVDC (IN 2.2) 20 mVAC / 100 mVDC (IN 2.3)
Response threshold (current)	1.5 mAAC / 7.5 mADC (IN 3.1) 3 mAAC / 10 mADC (IN 3.2) 7.5 mAAC / 12 mADC (IN 3.3)
Resolution (voltage)	50 mV (IN 2.1) 30 mV (IN 2.2) 5 mV (IN 2.3)
Resolution (current)	1 mA (for all measurement ranges)

Output (analog)

Output signal type	Current Voltage
Output signal (voltage)	± 12 V (SELV)
Output signal (current)	±24 mA (SELV)
Load impedance (voltage output)	≥ 2 kΩ
Load impedance (current output)	≤ 600 Ω

Output (digital)

Switching voltage (DO) max.	Supply voltage (applied): -0.3 V
Continuous current (DO) max.	100 mA (no internal restriction)
Number of switching thresholds (DO)	2 (max.)
Configurable rise/fall delay time (DO)	0 ... 60 s (via software)
Configurable functions (DO)	Disabled U _S /GND switching Threshold value switch Frequency generator Pulse output (S0 interface)
Setting range (frequency generator)	0.3 ... 100 Hz
Setting range (pulse output)	1000 ... 1 pulses/kW(h)

Output (relay)

Number of changeover/switchover contacts	1
Switching voltage (max.)	AC 250 V
Dielectric strength (open contact) (AC, 1 min)	1 kVrms
Number of switching thresholds (relay)	1 or 2 (adjustable)
Configurable rise/fall delay time (relay)	0 ... 60 s (via software)

Subject to changes. Please also observe the further product documentation!

Signal Processing

Measurement method	True RMS measurement (TRMS)
Measured variables (calculated)	Active power Apparent power Reactive power Mains frequency Phase angle
Limit frequency	2 kHz
Software filter (adjustable)	Filter level: 1 ... 30
Step response (max.)	350 ms (for default settings)

Measurement Error

Transmission error (max.)	≤ 0.5 % for current and voltage (of the full scale value)
---------------------------	---

Supply

Power supply type	24 VDC
Nominal supply voltage U_S	DC 24 V (SELV)
Supply voltage range	±30 %
Current consumption at nominal supply voltage	≤ 70 mA (+ I_{DO})

Safety and protection

Rated voltage	600 V; 300 V (UL)
Measurement category per EN/UL 61010-2-030	CAT III (input)
Note on insulation parameters	The digital output (DO) is at the potential of the supply. The service interface is located on the analog output potential.
Protection type	IP20

Test voltage

Test voltage (input IN 2.1/relay output; per EN 61010-1)	5.4 kVAC; 50 Hz; 5 s 3.6 kVAC; 50 Hz; 1 min
Test voltage (input IN 2.1/relay output; per UL 61010-1)	3.51 kVAC; 60 Hz; 1 min
Test voltage (input/supply and analog output/relay output)	3.51 kVAC; 50 ... 60 Hz; 1 min
Test voltage (supply/analog output)	3.6 kVAC; 50 ... 60 Hz; 1 min

Insulation parameters(UL)

Overvoltage category	III
----------------------	-----

Subject to changes. Please also observe the further product documentation!



Pollution degree	2
Insulation type (input/supply and analog output/relay output)	Reinforced insulation (safe isolation)

Insulation parameters

Overvoltage category	III
Pollution degree	2
Insulation type (input IN 2.1/relay output)	Reinforced insulation (safe isolation)
Insulation type (input/supply and analog output/relay output)	Double insulation (impedance and basic insulation) Requirement: The N (GND 1) input is dangerous when active!

Connection data

Connection technology	Push-in CAGE CLAMP®
WAGO connector	<i>picoMAX</i> ® 5.0
Solid conductor	0.2 ... 2.5 mm ² / 24 ... 12 AWG
Fine-stranded conductor	0.2 ... 2.5 mm ² / 24 ... 12 AWG
Strip length	9 ... 10 mm / 0.35 ... 0.39 inches

Physical data

Width	22.5 mm / 0.886 inches
Height	110 mm / 4.331 inches
Depth from upper-edge of DIN-rail	107 mm / 4.213 inches

Mechanical Data

Mounting type	DIN-35 rail
---------------	-------------

Material Data

Fire load	2.168 MJ
Weight	149 g

Environmental requirements

Ambient temperature (operation)	-40 ... +70 °C
Ambient temperature (storage)	-40 ... +85 °C
Temperature range of connection cable	≥ (T _{ambient} + 25 K)
Temperature range of connection cable (UL)	95 °C
Relative humidity	5 ... 85 % (non-condensing)

Subject to changes. Please also observe the further product documentation!



Operating altitude (max.)	2000 m
---------------------------	--------

Standards and specifications

Conformity marking	CE
EMC immunity to interference	EN 61000-6-2; EN 61326-2-3
EMC emission of interference	EN 61000-6-3; EN 61326-2-3
Standards/specifications	EN 61010-1 UL 61010-1 UL 61010-2-201

Commercial data

ETIM 8.0	EC002476
ETIM 7.0	EC002476
PU (SPU)	1 pcs
Packaging type	bag
Country of origin	DE
GTIN	4055143907323
Customs tariff number	85437090300

Environmental Product Compliance

CAS-No.	1314-23-4 1317-36-8 7439-92-1 79-94-7
REACH Candidate List Substance	2,2',6,6'-tetrabromo-4,4'-isopropylidenediphenol Lead Lead monoxide Perfluorobutane sulfonic acid (PFBS) and its salts Zirconium Oxide
RoHS Compliance Status	Compliant,With Exemption
RoHS Exemption	7(a) 7(c)-I 7(c)-II
SCIP notification number (Austria)	e9a0da3f-7ab8-4615-8bb8-51d84373ba4c
SCIP notification number (Belgium)	cde42bc2-2ed6-4b3f-b95b-c988d14bf8db
SCIP notification number (Bulgaria)	02ec92ad-0329-4305-b22b-9e24a0f958c9
SCIP notification number (Czech Republic)	d096da26-d7f8-4d5e-becc-86e2fb93012f
SCIP notification number (Denmark)	ea1432b2-fa84-46ab-8a5d-075664e979ef
SCIP notification number (Finland)	711a69de-5cbd-429b-a6d3-8ffed1a1b9f3

Subject to changes. Please also observe the further product documentation!



WAGO GmbH & Co. KG
Hansastr. 27
32423 Minden
Phone: +49571 887-0 | Fax: +49571 887-169
Email: info.de@wago.com | Web: www.wago.com

Do you have any questions about our products?
We are always happy to take your call at +49 (571) 887-44222.

SCIP notification number (France)	7750255c-4551-444f-b3c6-a4edfe120427
SCIP notification number (Germany)	f2d91d82-2ffe-4f8c-815a-b19f31daaf10
SCIP notification number (Hungary)	118e1f7b-e544-475b-8dbf-0016c1a2f149
SCIP notification number (Italy)	02841e02-dc41-4530-999f-a472b42b8822
SCIP notification number (Netherlands)	b182a8b9-fbbe-43c7-a18e-99b519fe0e2f
SCIP notification number (Poland)	f7f4ead4-ec70-41f8-88ec-eb9d615fea26
SCIP notification number (Romania)	0237191f-9eb4-45db-8b80-7a562cc49da6
SCIP notification number (Sweden)	7a289ca8-3605-43d8-9581-2947e0665a91

Approvals / Certificates

General approvals

Logo	Approval	Additional Approval Text	Certificate name
	EAC Brjansker Zertifizierungsstelle	TP TC 020/2011	EAC_Certificate_RU_C-DE.AM02.B.00115_19
	EAC Brjansker Zertifizierungsstelle	TP TC 004/2011	EAC RU C-DE.AM02.B.00122/19
	UL Underwriters Laboratories Inc. (ORDINARY LOCATIONS)	UL 61010-2-201	E175199

Declarations of conformity and manufacturer's declarations

Logo	Approval	Additional Approval Text	Certificate name
	EU-Declaration of Conformity WAGO GmbH & Co. KG	-	-

Optional accessories

Communication

Configuration display			
	Item no.: 2857-900 Configuration display		www.wago.com/2857-900
Communication cable			

Subject to changes. Please also observe the further product documentation!



Item no.: 750-923
Configuration cable; USB connector; Length: 2.5 m

www.wago.com/750-923



Item no.: 750-923/000-001
Configuration cable; USB connector; Length: 5 m

www.wago.com/750-923/000-001

Testing and measuring

Testing accessories



Item no.: 735-500
WAGO Test pin; 1 mm Ø; 30 V AC / 60 V DC; CAT0; 1 A; 6 mm uninsulated; Test lead for soldering up to 0,5mm² www.wago.com/735-500

Jumpers

Jumper



Item no.: 281-482
Jumper; 2-way; insulated; gray www.wago.com/281-482



Item no.: 859-402/000-029
Jumper; for jumper slot; 2-way; insulated; yellow www.wago.com/859-402/000-029



Item no.: 859-402/000-006
Jumper; for jumper slot; 2-way; insulated; blue www.wago.com/859-402/000-006



Item no.: 859-402
Jumper; for jumper slot; 2-way; insulated; light gray www.wago.com/859-402



Item no.: 859-402/000-005
Jumper; for jumper slot; 2-way; insulated; red www.wago.com/859-402/000-005

Power supplies

Power supply unit



Item no.: 787-2852
Switched-mode power supply; 1-phase; 24 VDC output voltage; 1 A output current www.wago.com/787-2852

Mounting

Mounting accessories



Item no.: 249-116
Screwless end stop; 6 mm wide; for DIN-rail 35 x 15 and 35 x 7.5; gray www.wago.com/249-116



Item no.: 249-117
Screwless end stop; 10 mm wide; for DIN-rail 35 x 15 and 35 x 7.5; gray www.wago.com/249-117

Subject to changes. Please also observe the further product documentation!

**Item no.: 249-197**

Screwless end stop; 14 mm wide; for DIN-rail 35 x 15 and 35 x 7.5; gray

www.wago.com/249-197

Marking accessories

Marking strip
**Item no.: 2009-110**

Marking strips; for Smart Printer; on reel; not stretchable; plain; snap-on type; white

www.wago.com/2009-110

Marker
**Item no.: 2009-115**

WMB-Inline; for Smart Printer; 1500 pieces on roll; stretchable 5 - 5.2 mm; plain; snap-on type; white

www.wago.com/2009-115**Item no.: 793-501**

WMB marking card; as card; not stretchable; plain; snap-on type; white

www.wago.com/793-501**Item no.: 793-502**

WMB marking card; as card; MARKED; 1 ... 10 (10x); not stretchable; Horizontal marking; snap-on type; white

www.wago.com/793-502**Item no.: 793-503**

WMB marking card; as card; MARKED; 11 ... 20 (10x); not stretchable; Horizontal marking; snap-on type; white

www.wago.com/793-503**Item no.: 793-504**

WMB marking card; as card; MARKED; 21 ... 30 (10x); not stretchable; Horizontal marking; snap-on type; white

www.wago.com/793-504**Item no.: 793-505**

WMB marking card; as card; MARKED; 31 ... 40 (10x); not stretchable; Horizontal marking; snap-on type; white

www.wago.com/793-505**Item no.: 793-506**

WMB marking card; as card; MARKED; 41 ... 50 (10x); not stretchable; Horizontal marking; snap-on type; white

www.wago.com/793-506**Item no.: 793-566**

WMB marking card; as card; MARKED; 1 ... 50 (2x); not stretchable; Horizontal marking; snap-on type; white

www.wago.com/793-566**Item no.: 793-5501**

WMB marking card; as card; for terminal block width 5 - 17.5 mm; stretchable 5 - 5.2 mm; plain; snap-on type; white

www.wago.com/793-5501**Item no.: 2009-141**

Micro-WSB-Inline; 2000 pieces on roll; plain; snap-on type; white

www.wago.com/2009-141

Terminal blocks

Supply module
**Item no.: 857-979**

Supply and through module

www.wago.com/857-979

Relay module

Subject to changes. Please also observe the further product documentation!

WAGO GmbH & Co. KG

Hansastr. 27

32423 Minden

Phone: +49571 887-0 | Fax: +49571 887-169

Email: info.de@wago.com | Web: www.wago.com

Do you have any questions about our products?

We are always happy to take your call at +49 (571) 887-44222.

Relay module

	Item no.: 857-304 Relay module; Nominal input voltage: 24 VDC; 1 changeover contact; Limiting continuous current: 6 A; Yellow status indicator; Module width: 6 mm; 2,50 mm ² ; gray	www.wago.com/857-304
---	---	--







Tool

Operating tool

	Item no.: 210-720 Operating tool; Blade: 3.5 x 0.5 mm; with a partially insulated shaft; multicoloured	www.wago.com/210-720
--	--	--

Voltage tap

Power tap

	Item no.: 855-8001 Power tap; with fuse; 2,5 mm ² (12 AWG) - 6 mm ² (10 AWG); Phase	www.wago.com/855-8001
	Item no.: 855-8002 Power tap; without fuse; 2,5 mm ² (12 AWG) - 6 mm ² (10 AWG); N-conductor	www.wago.com/855-8002
	Item no.: 855-8004 Power tap; without fuse; 10 mm ² (8 AWG) - 16 mm ² (6 AWG); N-conductor	www.wago.com/855-8004
	Item no.: 855-8003 Power tap; with fuse; 10 mm ² (8 AWG) - 16 mm ² (6 AWG); Phase	www.wago.com/855-8003
	Item no.: 855-8006 Power tap; for busbar; with fuse; Mounting screw M6	www.wago.com/855-8006
	Item no.: 855-8008 Power tap; for busbar; with fuse; Mounting screw M8	www.wago.com/855-8008
	Item no.: 855-8015 Power tap; for busbar; with fuse; Clamping connection	www.wago.com/855-8015

Downloads

Documentation

Instruction Leaflet

Single-Phase Power Signal Conditioner; Current and voltage input signal	V 2.0.0 2020 Sep 30	pdf 3.1 MB	Download
---	------------------------	---------------	----------

Additional Information

Disposal and Recycling	V 1.1.0	pdf	Download
------------------------	---------	-----	----------

Subject to changes. Please also observe the further product documentation!

Environmental Product Compliance

Compliance Search

Environmental Product Compliance 2857-569

[URL](#)

[Download](#)

Single-Phase Power Signal Conditioner; Current and voltage input signal; Current and voltage output signal; Digital output; Configuration via software; Supply voltage: 24 VDC

Installation Notes

Configuring

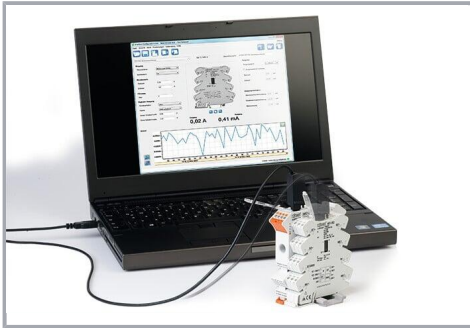

Configuration via WAGO Interface Configuration Software



Configuration via WAGO Configuration Display

Conductor termination



Pluggable connection technology



Commoning, not discrete wiring – Same outline allows use of a single in-line, push-in jumper.

Security

Subject to changes. Please also observe the further product documentation!

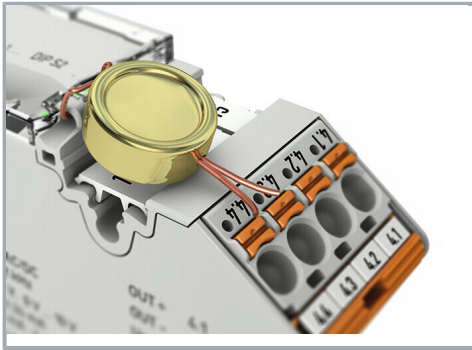

Lock-out seal option

Subject to changes. Please also observe the further product documentation!