

**Recommended PCB Layout**  
General Tolerance:  $\pm 0.05$   
Solder Area

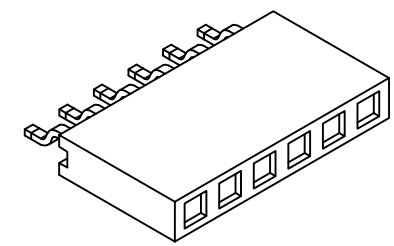

Number of Contacts	Dimensions	
	A	B
2	5.63	2.54
3	8.17	5.08
4	10.71	7.62
5	13.25	10.16
6	15.79	12.70

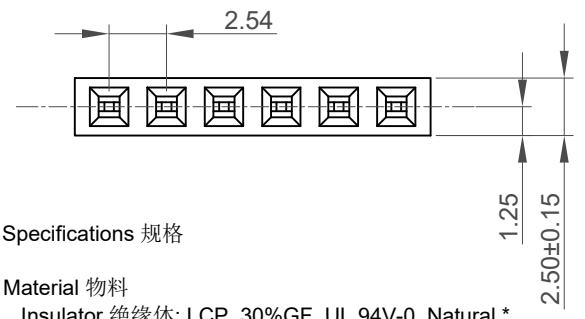

**Specifications 规格**

**Material 物料**  
Insulator 绝缘体: LCP, 30%GF, UL 94V-0, Natural \*  
Contact 接触: Copper Alloy

**Plating 电镀**  
Underplating 底层电镀: 50 $\mu$ "-100 $\mu$ " Nickel all over  
Contact Area 接触部分: See ordering grid

**Electrical 电气**  
Current Rating 电流额定值: 3A per pin  
Contact Resistance 接触电阻值: 20 m $\Omega$  max.  
Insulating Resistance 绝缘电阻值: 1000 M $\Omega$  min.  
Dielectric Withstand Voltage 耐电压: 500V AC

**Mechanical & Environmental 机械 & 环境**  
Operating Temperature 工作温度: -40 $^{\circ}$ C to +105 $^{\circ}$ C  
Mating Force 插入力: 35N (3.57Kgf) max.  
Unmating Force 拔出力: 10N (1.02Kgf) min.  
Durability 耐久性: 1,500 Cycles

**Soldering Process 可焊性:**  
IR Reflow 回流焊: 260 $^{\circ}$ C for 10 secs  
Manual Solder 人工焊接: 350 $^{\circ}$ C for 3-5 secs

**Mates with 配套之公头:**  
BG301 for perfect horizontal mating.  
(max. mating pin length 5.4mm)

\*Standard black insulator version of BG300 is BG230

**Ordering Grid**

**BG300** - **XX** - **X** - **L** - **A** Request Samples and Quotation

**No. of Contacts**  
02 to 06

**Contact Plating**  
A = Gold Flash All Over  
(Other plating options available on request)

**Packing**  
A = Tape and Reel  
(MOQ 1400pcs)

**Insulator Material**  
L = LCP (Natural)

Part Number		Product Description	
BG300		2.54mm Pitch Socket	
Drawing Date		Single Row, Surface Mount, Horizontal, Natural LCP	
7th December 2011			
By	CC	Tolerances (Except as Noted)	Units:
Detail	BG300	Length	Metric (mm)
Revision	C PCN	Angle	
Date	C2	X.X $\pm$ 0.30	
	21/03/17	X.XX $\pm$ 0.25	



This drawing is confidential and copyright of Global Connector Technology, Ltd (GCT). This drawing must not be copied or disclosed without written consent. E & OE



Not to Scale	Drawn By CM	Sheet No. 1/2
--------------	-------------	---------------

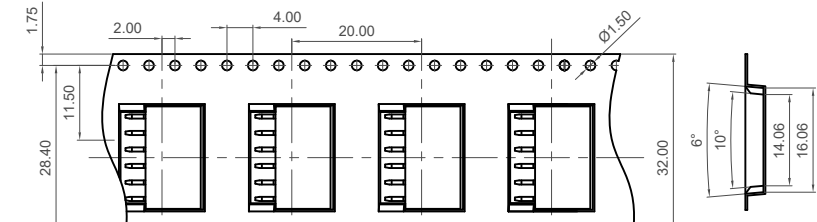
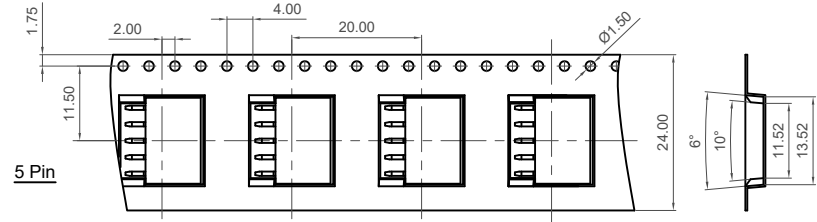
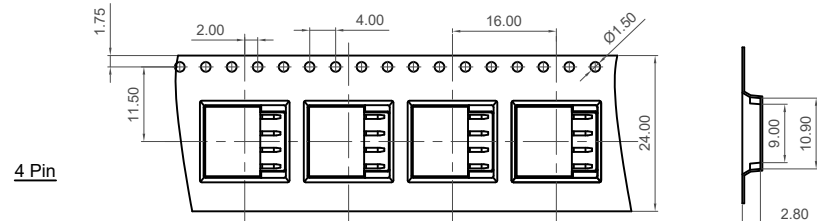
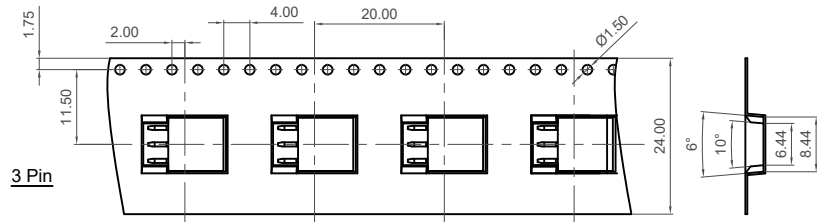
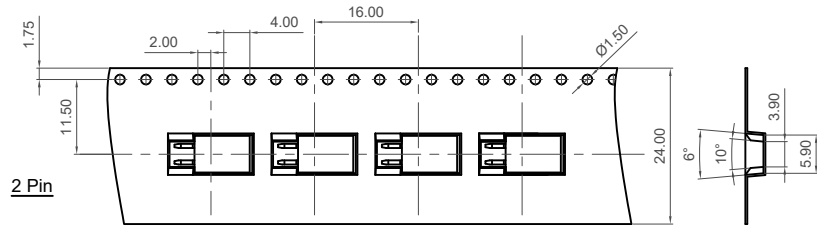

No. of Contacts	Units/ Reel	Reels/ Carton	Units/ Carton	Total Carrier Tape Length/Reel
2,3,4,5	1,400 pcs	10	14,000	23.1 m
6	1,400 pcs	8	11,200	23.1 m

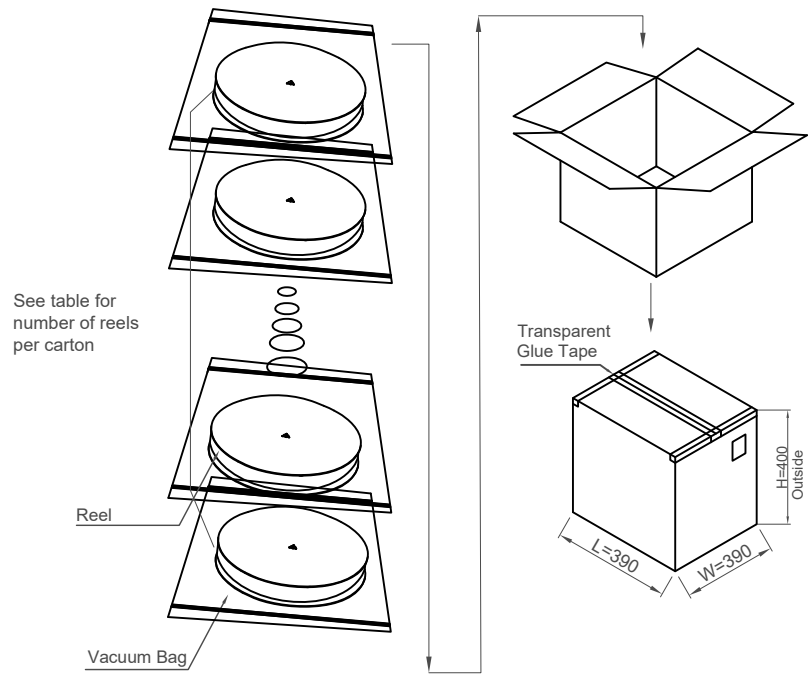
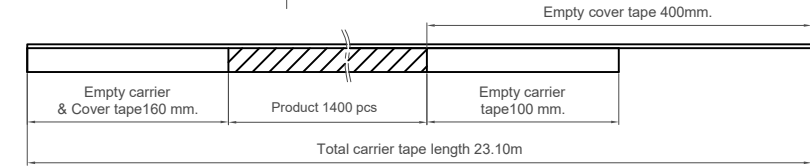
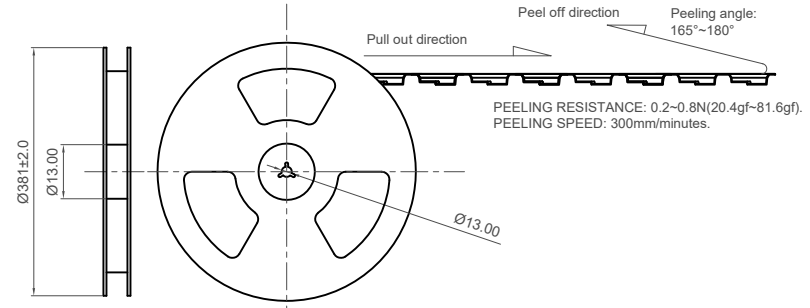

Part Number		Product Description	
BG300		2.54mm Pitch Socket	
Drawing Date		Single Row, Surface Mount, Horizontal, Natural LCP	
7th December 2011			
By	CC	Tolerances (Except as Noted)	
Detail	BG300 C PCN	Length	Angle
Revision	C2	Units: Metric (mm)	
Date	21/03/17		
		This drawing is confidential and copyright of Global Connector Technology, Ltd (GCT). This drawing must not be copied or disclosed without written consent. E & OE	

**GCT**  
www.gct.co

Not to Scale	Drawn By CM	Sheet No. 2/2
--------------	-------------	---------------