

Data sheet | Item number: 281-610

3-conductor carrier terminal block; for DIN-rail 35 x 15 and 35 x 7.5; 4 mm²; CAGE CLAMP®; 4,00 mm²; gray

www.wago.com/281-610

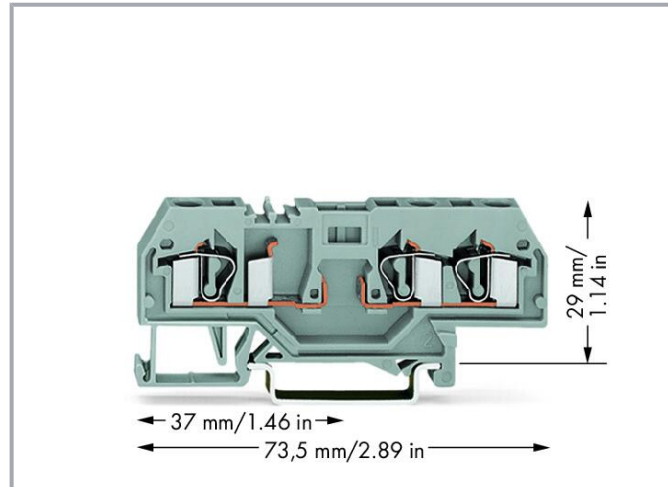
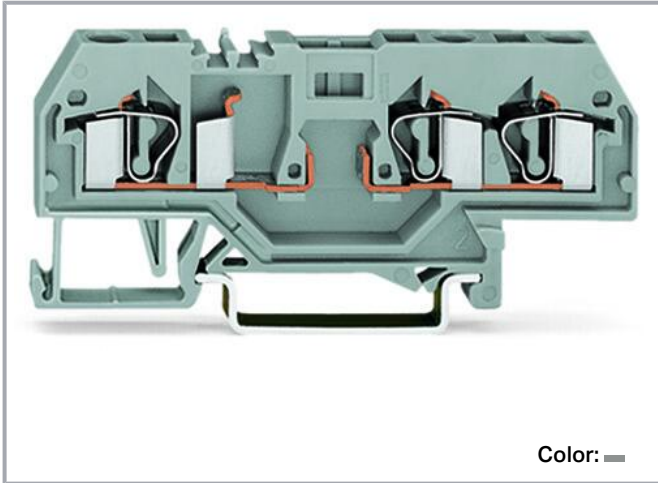

Data

Electrical data

Ratings per IEC/EN

Ratings per	IEC/EN 60947-7-1
Nominal voltage (III/3)	400 V
Rated impulse voltage (III/3)	6 kV
Rated current	10 A
Legend (ratings)	(III / 3) ≙ Overvoltage category III / Pollution degree 3

Power loss

Power loss, per pole (potential)	0.1 W
Rated current I_N for specified power loss	10 A
Resistance value for specified, current-dependent power loss	0.001 Ω

Connection data

Connection points	3
Total number of potentials	2
Number of levels	1

Subject to changes. Please also observe the further product documentation!

WAGO GmbH & Co. KG
Hansastr. 27
32423 Minden
Phone: +49571 887-0 | Fax: +49571 887-169
Email: info.de@wago.com | Web: www.wago.com

Do you have any questions about our products?
We are always happy to take your call at +49 (571) 887-44222.



Connection 1

Connection technology	CAGE CLAMP®
Actuation type	Operating tool
Connectable conductor materials	Copper Aluminum
Connectable conductor materials (note)	<p>Terminating Aluminum Conductors WAGO spring clamp terminal blocks are suitable for solid aluminum conductors up to 4 mm²/12 AWG if WAGO "Alu-Plus" Contact Paste 249-130 is used for termination.</p> <p>"Alu-Plus" Contact Paste Advantages:</p> <ul style="list-style-type: none"> ■ Automatically destroys the oxide film during clamping. ■ Prevents fresh oxidation at the clamping point. ■ Prevents electrolytic corrosion between aluminum and copper conductors (in the same terminal block). ■ Provides long-term protection against corrosion. <p>Using terminal blocks with CAGE CLAMP® Spring Pressure Connection Technology, aluminum conductors must first be cleaned with a blade and then immediately be inserted into the clamping units filled with "Alu-Plus" Contact Paste.</p> <p>It is also possible to apply WAGO "Alu-Plus" additionally on the whole surface of the aluminum conductor before termination.</p> <p>Please note that the nominal currents must be adapted to the reduced conductivity of the aluminum conductors:: 2.5 mm² = 16 A 4 mm² = 22 A</p>
Solid conductor	0.08 ... 4 mm ² / 28 ... 12 AWG
Fine-stranded conductor	0.08 ... 4 mm ² / 28 ... 12 AWG
Strip length	9 ... 10 mm / 0.35 ... 0.39 inches
Wiring direction	Front-entry wiring

Physical data

Width	6 mm / 0.236 inches
Height	73.5 mm / 2.894 inches
Depth from upper-edge of DIN-rail	29 mm / 1.142 inches

Subject to changes. Please also observe the further product documentation!

WAGO GmbH & Co. KG
Hansastr. 27
32423 Minden
Phone: +49571 887-0 | Fax: +49571 887-169
Email: info.de@wago.com | Web: www.wago.com

Do you have any questions about our products?
We are always happy to take your call at +49 (571) 887-44222.



Mechanical Data

Design	horizontal type
Mounting type	DIN-35 rail
Marking level	Center marking

Material Data

Note (material data)

Information on material specifications can be found here

Color	gray
Material group	I
Insulation material	Polyamide (PA66)
Flammability class per UL94	V0
Fire load	0.242 MJ
Weight	11.1 g

Environmental requirements

Processing temperature	-35 ... +85 °C
Continuous operating temperature	-60 ... +105 °C

Commercial data

Product Group	1 (Rail Mounted Terminal Blocks)
eCl@ss 10.0	27-14-11-20
eCl@ss 9.0	27-14-11-20
ETIM 8.0	EC000897
ETIM 7.0	EC000897
PU (SPU)	50 pcs
Packaging type	box
Country of origin	DE
GTIN	4044918631990
Customs tariff number	85369010000





Environmental Product Compliance

RoHS Compliance Status	Compliant, No Exemption
------------------------	-------------------------



Subject to changes. Please also observe the further product documentation!

Approvals / Certificates

General approvals

Logo	Approval	Additional Approval Text	Certificate name
	CCA DEKRA Certification B.V.	IEC 60947	NTR NL-7454/A1
	CSA DEKRA Certification B.V.	C22.2 No. 158	1505034
	KEMA/KEUR DEKRA Certification B.V.	EN 60947	71-107288
	UL Underwriters Laboratories Inc.	UL 1059	E45172

Declarations of conformity and manufacturer's declarations

Logo	Approval	Additional Approval Text	Certificate name
	EU-Declaration of Conformity WAGO GmbH & Co. KG	-	-
	UK-Declaration of Conformity WAGO GmbH & Co. KG	-	-

Approvals for marine applications

Logo	Approval	Additional Approval Text	Certificate name
	ABS American Bureau of Shipping	-	20-HG1941090-PDA
	BV Bureau Veritas S.A.	EN 60947	07436/F0 BV

Subject to changes. Please also observe the further product documentation!

WAGO GmbH & Co. KG
Hansastr. 27
32423 Minden
Phone: +49571 887-0 | Fax: +49571 887-169
Email: info.de@wago.com | Web: www.wago.com

Do you have any questions about our products?
We are always happy to take your call at +49 (571) 887-44222.

BUREAU
VERITAS

DNV GL

Det Norske Veritas, Germanischer Lloyd

-

TAE00001V2



LR

Lloyds Register

EN 60947

91/20112

(E9)



Required accessories

End plate

End plate



Item no.: 281-324

End and intermediate plate; 2.5 mm thick; gray

www.wago.com/281-324

Item no.: 281-326

End and intermediate plate; 2.5 mm thick; orange

www.wago.com/281-326

Optional accessories

Mounting

Mounting accessories



Item no.: 209-106

Mounting carrier; for isolated mounting on DIN 35 rails; gray

www.wago.com/209-106

Item no.: 249-116

Screwless end stop; 6 mm wide; for DIN-rail 35 x 15 and 35 x 7.5; gray

www.wago.com/249-116

Marking accessories

Marker



Item no.: 2009-115/000-002

WMB-Inline; for Smart Printer; 1500 pieces on roll; stretchable 5 - 5.2 mm; plain; snap-on type; yellow

www.wago.com/2009-115/000-002

Item no.: 2009-115/000-007

WMB-Inline; for Smart Printer; 1500 pieces on roll; stretchable 5 - 5.2 mm; plain; snap-on type; gray

www.wago.com/2009-115/000-007

Item no.: 2009-115/000-017

Subject to changes. Please also observe the further product documentation!

WAGO GmbH & Co. KG

Hansastr. 27











32423 Minden

Phone: +49571 887-0 | Fax: +49571 887-169

Email: info.de@wago.com | Web: www.wago.com

Do you have any questions about our products?

We are always happy to take your call at +49 (571) 887-44222.

	WMB-Inline; for Smart Printer; 1500 pieces on roll; stretchable 5 - 5.2 mm; plain; snap-on type; light green	www.wago.com/2009-115/000-017
	Item no.: 2009-115/000-023 WMB-Inline; for Smart Printer; 1500 pieces on roll; stretchable 5 - 5.2 mm; plain; snap-on type; green	www.wago.com/2009-115/000-023
	Item no.: 2009-115/000-024 WMB-Inline; for Smart Printer; 1500 pieces on roll; stretchable 5 - 5.2 mm; plain; snap-on type; violet	www.wago.com/2009-115/000-024
	Item no.: 2009-115 WMB-Inline; for Smart Printer; 1500 pieces on roll; stretchable 5 - 5.2 mm; plain; snap-on type; white	www.wago.com/2009-115
	Item no.: 793-5501/000-007 WMB marking card; as card; for terminal block width 5 - 17.5 mm; stretchable 5 - 5.2 mm; plain; snap-on type; gray	www.wago.com/793-5501/000-007
	Item no.: 793-5501/000-012 WMB marking card; as card; for terminal block width 5 - 17.5 mm; stretchable 5 - 5.2 mm; plain; snap-on type; orange	www.wago.com/793-5501/000-012
	Item no.: 793-5501/000-017 WMB marking card; as card; for terminal block width 5 - 17.5 mm; stretchable 5 - 5.2 mm; plain; snap-on type; light green	www.wago.com/793-5501/000-017
	Item no.: 793-5501/000-023 WMB marking card; as card; for terminal block width 5 - 17.5 mm; stretchable 5 - 5.2 mm; plain; snap-on type; green	www.wago.com/793-5501/000-023
	Item no.: 793-5501/000-024 WMB marking card; as card; for terminal block width 5 - 17.5 mm; stretchable 5 - 5.2 mm; plain; snap-on type; violet	www.wago.com/793-5501/000-024
	Item no.: 793-501/000-002 WMB marking card; as card; not stretchable; plain; snap-on type; yellow	www.wago.com/793-501/000-002
	Item no.: 793-501/000-007 WMB marking card; as card; not stretchable; plain; snap-on type; gray	www.wago.com/793-501/000-007

Subject to changes. Please also observe the further product documentation!



Item no.: 793-501/000-017

WMB marking card; as card; not stretchable; plain; snap-on type; light green

www.wago.com/793-501/000-017



Item no.: 793-501/000-012

WMB marking card; as card; not stretchable; plain; snap-on type; orange

www.wago.com/793-501/000-012



Item no.: 793-501/000-023

WMB marking card; as card; not stretchable; plain; snap-on type; green

www.wago.com/793-501/000-023



Item no.: 793-501/000-006

WMB marking card; as card; not stretchable; plain; snap-on type; blue

www.wago.com/793-501/000-006



Item no.: 793-501/000-005

WMB marking card; as card; not stretchable; plain; snap-on type; red

www.wago.com/793-501/000-005



Item no.: 793-501

WMB marking card; as card; not stretchable; plain; snap-on type; white

www.wago.com/793-501



Item no.: 793-501/000-024

WMB marking card; as card; not stretchable; plain; snap-on type; violet

www.wago.com/793-501/000-024



Item no.: 793-5501/000-005

WMB marking card; as card; for terminal block width 5 - 17.5 mm; stretchable 5 - 5.2 mm; plain; snap-on type; red

www.wago.com/793-5501/000-005



Item no.: 793-5501/000-002

WMB marking card; as card; for terminal block width 5 - 17.5 mm; stretchable 5 - 5.2 mm; plain; snap-on type; yellow

www.wago.com/793-5501/000-002



Item no.: 793-5501/000-006

WMB marking card; as card; for terminal block width 5 - 17.5 mm; stretchable 5 - 5.2 mm; plain; snap-on type; blue

www.wago.com/793-5501/000-006



Item no.: 793-5501

WMB marking card; as card; for terminal block width 5 - 17.5 mm; stretchable 5 - 5.2 mm; plain; snap-on type; white

www.wago.com/793-5501

Subject to changes. Please also observe the further product documentation!

WAGO GmbH & Co. KG

Hansastr. 27

32423 Minden

Phone: +49571 887-0 | Fax: +49571 887-169

Email: info.de@wago.com | Web: www.wago.com

Do you have any questions about our products?

We are always happy to take your call at +49 (571) 887-44222.

	Item no.: 2009-115/000-012 WMB-Inline; for Smart Printer; 1500 pieces on roll; stretchable 5 - 5.2 mm; plain; snap-on type; orange	www.wago.com/2009-115/000-012
--	--	--

	Item no.: 2009-115/000-006 WMB-Inline; for Smart Printer; 1500 pieces on roll; stretchable 5 - 5.2 mm; plain; snap-on type; blue	www.wago.com/2009-115/000-006
--	--	--

Group marker carrier

	Item no.: 249-105 Group marker carrier; gray	www.wago.com/249-105
--	--	--

Insulation stop

Insulation stop

	Item no.: 281-470 Insulation stop; 0.08 - 0.2 mm ² "s" (0.14 mm ² "f-st"); 5 pieces/strip; white	www.wago.com/281-470
--	--	--

	Item no.: 281-471 Insulation stop; 0.25 - 0.5 mm ² ; 5 pieces/strip; light gray	www.wago.com/281-471
--	--	--

	Item no.: 281-472 Insulation stop; 0.75 - 1.5 mm ² ; 5 pieces/strip; dark gray	www.wago.com/281-472
--	---	--

Plugs

Fuse plug

	Item no.: 281-511 Fuse plug; with pull-tab; for miniature metric fuses 5 x 20 mm and 5 x 25 mm; without blown fuse indication; 6 mm wide; gray	www.wago.com/281-511
--	--	--

	Item no.: 281-512/281-501 Fuse plug; with pull-tab; for miniature metric fuses 5 x 20 mm and 5 x 25 mm; with LED indicator; 24 V AC/DC; 6 mm wide; gray	www.wago.com/281-512/281-501
--	---	--

	Item no.: 281-512 Fuse plug; with pull-tab; for miniature metric fuses 5 x 20 mm and 5 x 25 mm; with port for LED; 6 mm wide; gray	www.wago.com/281-512
--	--	--

	Item no.: 281-512/281-418 Fuse plug; with pull-tab; for miniature metric fuses 5 x 20 mm and 5 x 25 mm; with blown fuse indication by neon lamp; 120 V; 6 mm wide; gray	www.wago.com/281-512/281-418
--	---	--

	Item no.: 281-512/281-417 Fuse plug; with pull-tab; for miniature metric fuses 5 x 20 mm and 5 x 25 mm; with blown fuse indication by neon lamp; 230 V; 6 mm wide; gray	www.wago.com/281-512/281-417
--	---	--

Push-in type wire jumper

Jumper

	Item no.: 249-123 Push-in type wire jumper; 0.75 mm ² ; insulated; 180 mm long; black	www.wago.com/249-123
--	--	--

Subject to changes. Please also observe the further product documentation!

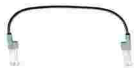

Item no.: 249-126
Push-in type wire jumper; 0.75 mm²; insulated; 110 mm long; black

www.wago.com/249-126



Item no.: 249-127
Push-in type wire jumper; 0.75 mm²; insulated; 250 mm long; black

www.wago.com/249-127



Item no.: 249-125
Push-in type wire jumper; insulated; 60 mm long; black

www.wago.com/249-125

Tool

Operating tool



Item no.: 210-657
Operating tool; Blade: 3.5 x 0.5 mm; with a partially insulated shaft; short; multicoloured

www.wago.com/210-657



Item no.: 210-658
Operating tool; Blade: 3.5 x 0.5 mm; with a partially insulated shaft; angled; short; multicoloured

www.wago.com/210-658



Item no.: 210-720
Operating tool; Blade: 3.5 x 0.5 mm; with a partially insulated shaft; multicoloured

www.wago.com/210-720

Carrier rail

Mounting accessories



Item no.: 210-197
Steel carrier rail; 35 x 15 mm; 1.5 mm thick; 2 m long; slotted; similar to EN 60715; silver-colored

www.wago.com/210-197



Item no.: 210-198
Copper carrier rail; 35 x 15 mm; 2.3 mm thick; 2 m long; unslotted; according to EN 60715; copper-colored

www.wago.com/210-198



Item no.: 210-504
Steel carrier rail; 35 x 7.5 mm; 1 mm thick; 2 m long; slotted; galvanized; according to EN 60715; silver-colored

www.wago.com/210-504



Item no.: 210-505
Steel carrier rail; 35 x 7.5 mm; 1 mm thick; 2 m long; unslotted; galvanized; according to EN 60715; silver-colored

www.wago.com/210-505

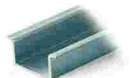

Item no.: 210-506
Steel carrier rail; 35 x 15 mm; 1.5 mm thick; 2 m long; unslotted; galvanized; similar to EN 60715; silver-colored

www.wago.com/210-506



Item no.: 210-508
Steel carrier rail; 35 x 15 mm; 1.5 mm thick; 2 m long; slotted; galvanized; similar to EN 60715; silver-colored

www.wago.com/210-508



Item no.: 210-113
Steel carrier rail; 35 x 7.5 mm; 1 mm thick; 2 m long; unslotted; according to EN 60715; silver-colored

www.wago.com/210-113

Subject to changes. Please also observe the further product documentation!

WAGO GmbH & Co. KG

Hansastr. 27



32423 Minden

Phone: +49571 887-0 | Fax: +49571 887-169















Email: info.de@wago.com | Web: www.wago.com

Do you have any questions about our products?

We are always happy to take your call at +49 (571) 887-44222.

	Item no.: 210-118 Steel carrier rail; 35 x 15 mm; 2.3 mm thick; 2 m long; unslotted; according to EN 60715; silver-colored	www.wago.com/210-118
	Item no.: 210-112 Steel carrier rail; 35 x 7.5 mm; 1 mm thick; 2 m long; slotted; according to EN 60715; "Hole width 25 mm; silver-colored	www.wago.com/210-112
	Item no.: 210-114 Steel carrier rail; 35 x 15 mm; 1.5 mm thick; 2 m long; unslotted; similar to EN 60715; silver-colored	www.wago.com/210-114
	Item no.: 210-115 Steel carrier rail; 35 x 7.5 mm; 1 mm thick; 2 m long; slotted; according to EN 60715; "Hole width 18 mm; silver-colored	www.wago.com/210-115
	Item no.: 210-196 Aluminum carrier rail; 35 x 8.2 mm; 1.6 mm thick; 2 m long; unslotted; similar to EN 60715; silver-colored	www.wago.com/210-196
Ferrule		
Ferrule		
	Item no.: 216-106 Ferrule; Sleeve for 2.5 mm ² / AWG 14; uninsulated; electro-tin plated; silver-colored	www.wago.com/216-106
	Item no.: 216-203 Ferrule; Sleeve for 1 mm ² / AWG 18; insulated; electro-tin plated; red	www.wago.com/216-203
	Item no.: 216-206 Ferrule; Sleeve for 2.5 mm ² / AWG 14; insulated; electro-tin plated; blue	www.wago.com/216-206
	Item no.: 216-202 Ferrule; Sleeve for 0.75 mm ² / 18 AWG; insulated; electro-tin plated; gray	www.wago.com/216-202
	Item no.: 216-204 Ferrule; Sleeve for 1.5 mm ² / AWG 16; insulated; electro-tin plated; black	www.wago.com/216-204
	Item no.: 216-205 Ferrule; Sleeve for 2.08 mm ² / AWG 14; insulated; electro-tin plated; yellow	www.wago.com/216-205
	Item no.: 216-201 Ferrule; Sleeve for 0.5 mm ² / 20 AWG; insulated; electro-tin plated; white	www.wago.com/216-201
	Item no.: 216-241 Ferrule; Sleeve for 0.5 mm ² / 20 AWG; insulated; electro-tin plated; electrolytic copper; gastight crimped; acc. to DIN 46228, Part 4/09.90; white	www.wago.com/216-241
	Item no.: 216-242 Ferrule; Sleeve for 0.75 mm ² / 18 AWG; insulated; electro-tin plated; electrolytic copper; gastight crimped; acc. to DIN 46228, Part 4/09.90; gray	www.wago.com/216-242
	Item no.: 216-243 Ferrule; Sleeve for 1 mm ² / AWG 18; insulated; electro-tin plated; electrolytic copper; gastight crimped; acc. to DIN 46228, Part 4/09.90; red	www.wago.com/216-243
	Item no.: 216-244 Ferrule; Sleeve for 1.5 mm ² / AWG 16; insulated; electro-tin plated; electrolytic copper; gastight crimped; acc. to DIN 46228, Part 4/09.90; black	www.wago.com/216-244

Subject to changes. Please also observe the further product documentation!

	<p>Item no.: 216-246 Ferrule; Sleeve for 2.5 mm² / AWG 14; insulated; electro-tin plated; electrolytic copper; gastight crimped; acc. to DIN 46228, Part 4/09.90; blue</p>	www.wago.com/216-246
	<p>Item no.: 216-301 Ferrule; Sleeve for 0.25 mm² / AWG 24; insulated; electro-tin plated; yellow</p>	www.wago.com/216-302
	<p>Item no.: 216-302 Ferrule; Sleeve for 0.34 mm² / 22 AWG; insulated; electro-tin plated; light turquoise</p>	www.wago.com/216-302
Protective warning marker		
Cover		
	<p>Item no.: 281-415 Protective warning marker; for 5 terminal blocks; with high-voltage symbol, black; yellow</p>	www.wago.com/281-415
Jumpers		
Jumper		
	<p>Item no.: 210-123 Wire commoning chain; insulated; blue</p>	www.wago.com/210-123
	<p>Item no.: 210-103 Wire commoning chain; insulated; black</p>	www.wago.com/210-103
	<p>Item no.: 281-485 Jumper; 5-way; insulated; gray</p>	www.wago.com/281-485
	<p>Item no.: 281-490 Jumper; 10-way; insulated; gray</p>	www.wago.com/281-490
	<p>Item no.: 281-492 Jumper; 2-way; insulated; gray</p>	www.wago.com/281-492
	<p>Item no.: 281-482 Jumper; 2-way; insulated; gray</p>	www.wago.com/281-482
	<p>Item no.: 281-483 Jumper; 3-way; insulated; gray</p>	www.wago.com/281-483
	<p>Item no.: 709-110 Wire commoning chain; 2.5 mm²; insulated; black</p>	www.wago.com/709-110
	<p>Item no.: 709-112 Wire commoning chain; 2.5 mm²; insulated; black</p>	www.wago.com/709-112
	<p>Item no.: 709-111 Wire commoning chain; 2.5 mm²; insulated; black</p>	www.wago.com/709-111

Subject to changes. Please also observe the further product documentation!



Downloads

Documentation

Bid Text

281-610 X81 - Datei	2019 Feb 19	xml 3.2 kB	Download
------------------------	-------------	---------------	----------

281-610 doc - Datei	2017 May 2	doc 25.1 kB	Download
------------------------	------------	----------------	----------

Additional Information

Technical Section Technical explanations		pdf 2.2 MB	Download
---	--	---------------	----------

CAD/CAE-Data

CAD data

2D/3D Models 281-610		URL	Download
----------------------	--	-----	----------

CAE data

EPLAN Data Portal 281-610		URL	Download
---------------------------	--	-----	----------

ZUKEN Portal 281-610		URL	Download
----------------------	--	-----	----------

WSCAD Universe 281-610		URL	Download
------------------------	--	-----	----------

Environmental Product Compliance

Compliance Search

Environmental Product Compliance 281-610 3-conductor carrier terminal block; for DIN-rail 35 x 15 and 35 x 7.5; 4 mm ² ; CAGE CLAMP®; 4,00 mm ² ; gray		URL	Download
---	--	-----	----------

Installation Notes

Subject to changes. Please also observe the further product documentation!

WAGO GmbH & Co. KG
Hansastr. 27
32423 Minden
Phone: +49571 887-0 | Fax: +49571 887-169
Email: info.de@wago.com | Web: www.wago.com

Do you have any questions about our products?
We are always happy to take your call at +49 (571) 887-44222.