



DSL-0803-G02MC

SICK
Sensor Intelligence.



Illustration may differ

Ordering information

Type	Part no.
DSL-0803-G02MC	6029406

Other models and accessories → www.sick.com/

Detailed technical data

Technical specifications

Accessory group	Plug connectors and cables						
Accessory family	Connection cables						
Connection type head A	Female connector, M8, 3-pin, straight						
Connection type head B	Male connector, M8, 3-pin, straight						
Connector material	TPU						
Connector color	Black						
Locking nut material	Zinc die-cast, nickel-plated						
Tightening torque	0.2 Nm						
Cable	2 m, 3-wire, PUR, halogen-free						
Jacket material	PUR, halogen-free						
Jacket color	Black						
Cable diameter	4.4 mm						
Conductor cross-section	0.25 mm ²						
Shielding	Unshielded						
Bending radius	<table border="0"> <tr> <td style="padding-right: 20px;">Flexible use</td> <td>> 10 x cable diameter</td> </tr> <tr> <td>Stationary position</td> <td>> 5 x cable diameter</td> </tr> </table>	Flexible use	> 10 x cable diameter	Stationary position	> 5 x cable diameter		
Flexible use	> 10 x cable diameter						
Stationary position	> 5 x cable diameter						
Bending cycles	≥ 4,000,000						
Reference voltage	≤ 60 V						
Current loading	4 A						
Traversing speed	3 m/s						
Travelling distance	10 m						
Acceleration	≤ 10 m/s ²						
Application	Zones with oils and lubricants Drag chain operation						
UL File No.	CYJV.E335179						
Enclosure rating	IP65/ IP67/ IP68						
Ambient operating temperature	<table border="0"> <tr> <td style="padding-right: 20px;">Flexible use</td> <td>-25 °C ... +80 °C</td> </tr> <tr> <td>Stationary position</td> <td>-40 °C ... +80 °C</td> </tr> <tr> <td>Head</td> <td>-25 °C ... +90 °C</td> </tr> </table>	Flexible use	-25 °C ... +80 °C	Stationary position	-40 °C ... +80 °C	Head	-25 °C ... +90 °C
Flexible use	-25 °C ... +80 °C						
Stationary position	-40 °C ... +80 °C						
Head	-25 °C ... +90 °C						

Classifications

ECl@ss 5.0	19030312
ECl@ss 5.1.4	19030312
ECl@ss 6.0	27060304
ECl@ss 6.2	27060304
ECl@ss 7.0	27060304
ECl@ss 8.0	27060304
ECl@ss 8.1	27060304
ECl@ss 9.0	27060304
ETIM 5.0	EC000830
ETIM 6.0	EC000830
UNSPSC 16.0901	26121604

Dimensional drawing (Dimensions in mm (inch))

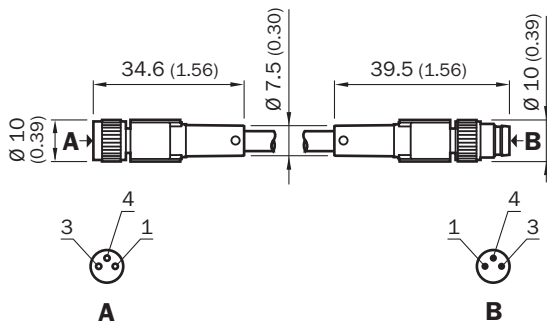

SICK AT A GLANCE

SICK is one of the leading manufacturers of intelligent sensors and sensor solutions for industrial applications. A unique range of products and services creates the perfect basis for controlling processes securely and efficiently, protecting individuals from accidents and preventing damage to the environment.

We have extensive experience in a wide range of industries and understand their processes and requirements. With intelligent sensors, we can deliver exactly what our customers need. In application centers in Europe, Asia and North America, system solutions are tested and optimized in accordance with customer specifications. All this makes us a reliable supplier and development partner.

Comprehensive services complete our offering: SICK LifeTime Services provide support throughout the machine life cycle and ensure safety and productivity.

For us, that is “Sensor Intelligence.”

WORLDWIDE PRESENCE:

Contacts and other locations –www.sick.com